

SERVE GOODNESS. ALL DAY.

SYRUP WARMERS/SERVERS

Simplify warming and serving high volumes of specialty sauces and syrups – server holds up to 3 gallons

Multi-daypart use – switch from breakfast syrup to ciders or mulled wine



Keeps syrups warm away from the kitchen

Compact design uses minimal counter space

No more sticky bottles or dispensers – faucet keeps area clean



SYRUP WARMERS/SERVERS

Models SY 1.5 & SY

Food Applications

- Keep syrups and sauces warm away from the kitchen; perfect for buffet lines
- Large capacity is ideal for multi-daypart use and for specialty drinks such as mulled wine and apple cider

Fast Facts

Warm and serve up to 3 gallons of breakfast syrup or specialty sauces in less than 10 inches of counter space.

Temperature-sensing thermostat is pre-set and locked at 140°F (60°C) to prevent accidental changes, and is also adjustable. Contents stay warm and on hand throughout the day.

Syrup is good for more than breakfast items – top specialty desserts or even sweet and savory soups.



1.800.558.8722
Server-Products.com

NO NEED TO MULL OVER THIS SWEET DEAL.

SYRUP WARMERS/SERVERS

Models SY 1.5 & SY

Specifier Statement

Server Products Syrup Warmer Models SY 1.5 and SY are constructed of stainless steel with a brushed finish. Warmers have a 1 1/2 or 3 gallon capacity. Traditional faucet style spigot is made of black plastic. Adjustable thermostat controls a 350 watt heating element precalibrated at 140°F (60°C) – temps range from 80°F to 180°F. Thermostat lock prevents accidental changes. NSF listed. C-UL-US listed. Two-year warranty. Ships FOB Richfield, WI 53076.

Product Code

- Syrup Server, 1.5 gallon SY 1.5 85480
- Syrup Server, 3 gallon SY 84190

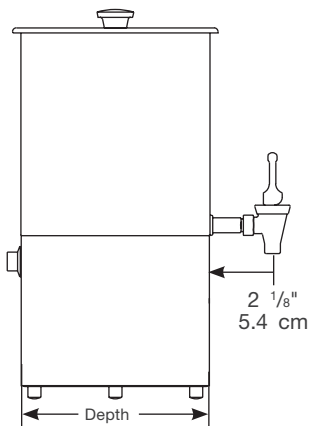
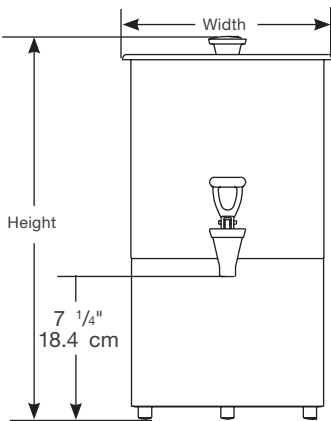

Specifications

Part Number	Capacity	Dimensions (height x width x depth)	Weight	Electrical
85480	1 1/2 gal	16 1/2" x 8 1/8" x 7 1/4" 41.9 x 20.6 x 18.4 cm	8 lb 3.6 kg	120V 350W 2.9A
84190	3 gal	19 5/16" x 9 7/8" x 9" 49.1 x 25.1 x 22.9 cm	10 lb 4.5 kg	120V 350W 2.9A

 Plug is NEMA 5-15P with 72" (183 cm) cord



Related Item

Server's Mix-N-Serve® Butter Warmer/Mixer continuously stirs using a magnetic agitator to keep contents from separating. A removable melting basket suspends butter solids for replenishing throughout the day.



Mix-N-Serve®
Butter Warmer/Mixer



Server Products, Inc. 800.558.8722 | Intl: 262.628.5600
3601 Pleasant Hill Road | Richfield WI 53076
spsales@server-products.com | server-products.com

Server Products, Inc. reserves the right to modify specifications without obligation.
Printed in USA | © Server Products, Inc 10.2017 | S 02011