

DECREASE WASTE. INCREASE WOW.

EZ-TOPPER™ POUCHED TOPPING WARMERS

Dispense more servings with eco-friendly pouched topping dispensers; deliver up to 98% evacuation and create 97% less packaging waste than cans

Minimize downtime during changeouts – models available to simultaneously warm a reserve pouch

Promote dessert consistency with portion control; 1 oz pump serving is adjustable in 1/8 oz increments



Adjustable thermostat heats and holds temperature as topping depletes to avoid scorching



Sealed, sanitary system keeps topping safe and avoids product degradation; containment simplifies cleanup by keeping pump exterior clean



EZ-TOPPER™ DISPENSERS

Models EZT & EZT-S

Food Applications

- Ideal for self-serve dessert stations as tamper-resistant packaging brings peace of mind
- High-volume operations looking to optimize downtime during changeouts
- Lower-volume or sporadic use operations serving topping over an extended period of time

Fast Facts

EZ-Topper warmers serve up to 98% of your Fudge or Caramel from special 48 oz pouches with 16 mm center fitment, available through your food distributor.

Adjustable portion control pump ensures dessert consistency; max 1 oz serving reduces in 1/8 oz increments.

Models accommodate large and small operations, serving 1 or 2 toppings with or without the ability to pre-heat a reserve pouch; single unit also available without spout heater.



EZT-S & EZT short models



1.800.558.8722
EZ-Topper.com

EZ-TOPPER™ POUCHED TOPPING WARMERS Models EZT & EZT-S

MORE SERVINGS. MORE RESPONSIBLE. SWEET.

EZ-TOPPER™ POUCHED TOPPING WARMERS

Model EZT & EZT-S

Specifier Statement

EZ-Topper™ unit will be one of (2) EZT Twin or (3) EZT-S Single topping warmer models by Server Products. Models accept specialized 48 oz (1.4 L) topping pouches with 16 mm center fitment and are available with and without room to pre-heat a reserve pouch; plus a single, tall non-spout heater model. Twin warmers use individual temperature sensing thermostats to control wrap-around heating elements for accurate heating and holding. Temperatures range from 100°F (38°C) to 200°F (93°C). Pumps dispense 1 oz (30 mL) max stroke adjustable in 1/8 oz (3.9 mL) increments. Black knobs standard; units include black engraved replacement knobs reading Caramel and Fudge. NSF listed. C-UL-US listed. Two-year warranty. Ships FOB Richfield, WI 53076.

EZ-Topper™ Product Codes

- Twin Tall with Heated Spout EZT 85899
- Single Tall with Heated Spout EZT-S 85790
- Single Short with Heated Spout EZT-S 85880
- Twin Short with Heated Spout EZT 85920
- Single Tall without Heated Spout EZT-S 85860

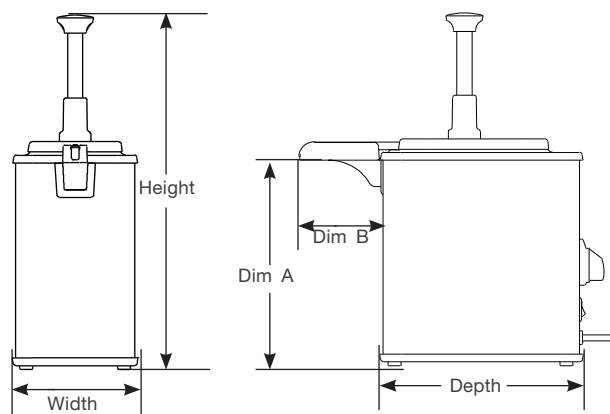

Specifications

Models	85899	85790	85880	85920	85860
Capacity	(4) 48oz pouches; (2) active (2) reserve	(2) 48oz pouches; (1) active (1) reserve	(1) 48oz pouch	(2) 48oz pouches	(2) 48oz pouches; (1) active (1) reserve
Height	17 3/8" 44.1 cm	17 3/8" 44.1 cm	13 15/16" 35.4 cm	13 15/16" 35.4 cm	17 3/8" 44.1 cm
Width	11 7/8" 30.2 cm	6" 15.2 cm	6" 15.2 cm	11 7/8" 30.2 cm	6" 15.2 cm
Depth	9 5/8" 24.4 cm	9 5/8" 24.4 cm	9 5/8" 24.4 cm	9 5/8" 24.4 cm	9 5/8" 24.4 cm
Dim A	10 1/4" 26.1 cm	10 1/4" 26.1 cm	6 13/16" 17.3 cm	6 13/16" 17.3 cm	10 1/4" 26.1 cm
Dim B	3 7/8" 9.8 cm	3 7/8" 9.8 cm	3 7/8" 9.8 cm	3 7/8" 9.8 cm	3 7/8" 9.8 cm
Weight	26 lb 11.8 kg	14 lb 6.4 kg	12 lb 5.4 kg	23 lb 10.4 kg	14 lb 6.4 kg
Electrical	120 V 400 W 3.3 A	120 V 200 W 1.7 A	120 V 150 W 1.3 A	120 V 300 W 2.5 A	120 V 200 W 1.7 A



Plug is NEMA 5-15P with 72" (183 cm) cord



Related Items

SlimLine™ Dry Food Dispensers display and dispense preset portions of up to (4) candies, toppings, or mix-ins in less than 13" of wall space. Control costs with precise portion control; color-coded trays identify serving size. Stands are available for countertop dispensing.



Server Products, Inc. | 800.558.8722 | Intl: 262.628.5600
3601 Pleasant Hill Road | Richfield WI 53076
spsales@server-products.com | server-products.com

Server Products, Inc. reserves the right to modify specifications without obligation.
Printed in USA | © Server Products, Inc 01.2019 | S 02080