

Standard Models:  ICP-100  ICP-200  ICP-300  ICP-400  ICP-500  ICP-600

Curved Models:  ICPC-200  ICPC-300  ICPC-400  ICPC-500

Narrow Models:  ICPN-200  ICPN-300

PRODUCT:

QUANTITY:

ITEM:

## Designed Smart

The Non-Refrigerated Drop-In Ice Pan is portable and provides an economic solution to the cost of in-counter cold storage. Designed to hold pre-chilled food products at serving temperatures. Uses ice below pans for cooling. Available in curved or narrow configurations.



## APW Wyott Design Features

- Stainless steel construction with fully insulated walls
- Drop-in Design
- NSF-2 Compliant
- Stainless steel holding clips secure pans
- Holds standard steam table pans and fractional sized pans
  - 100 Models fit one standard 12" x 20" pan
  - 200 Models fit two standard 12" x 20" pans
  - 300 Models fit three standard 12" x 20" pans
  - 400 Models fit four standard 12" x 20" pans
  - 500 Models fit five standard 12" x 20" pans
  - 600 Models fit six standard 12" x 20" pans
- Push in perimeter gasket
- Stainless steel louver provided
- Environmentally friendly HFC-134A refrigerant
- Thermostat for temperature control
- 1" Drain allows for easy cleaning
- Perforated bottom strainer plate conveniently hold ice above drain to prevent clogging
- Each pan has a large 1-inch drain located in the center for easy cleaning
- Recessed top edges lowers inset pan, keeping food colder and fresher
- Adapter bars are included with each unit to allow use of a variety of different sizes pans

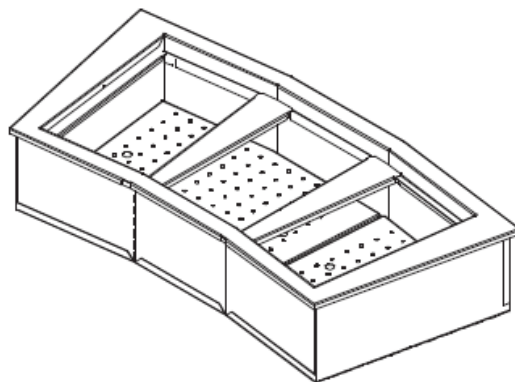

## Reliability Backed by APW Wyott's Warranty

1-year parts and labor warranty, including on-site service calls within 50 miles of authorized service technicians.

Certified by the following agencies:



Standard Models:  ICP-100  ICP-200  ICP-300  ICP-400  ICP-500  ICP-600

Curved Models:  ICPC-200  ICPC-300  ICPC-400  ICPC-500

Narrow Models:  ICPN-200  ICPN-300

PRODUCT:

QUANTITY:

ITEM:

## PRODUCT SPECIFICATIONS:

### Construction:

Stainless steel construction with fully insulated walls. 5/8" legs included.

### Standard Models

#### Overall Dimensions:

ICP-100: 19-1/2"Hx28"Wx11-13/16"D

ICP-200: 28"Hx32-13/16"Wx11-13/16"D

ICP-300: 28"Hx46-1/8"Wx11-13/16"D

ICP-400: 28"Hx59-7/16"Wx11-13/16"D

ICP-500: 28"Hx72-3/4"Wx11-13/16"D

ICP-600: 9-3/4"x 86"x 25-3/8"D

#### Ship Weight:

ICP-100: 72 LBS

ICP-200: 126 LBS

ICP-300: 150 LBS

ICP-400: 180 LBS

ICP-500: 274 LBS

ICP-600: 290 LBS

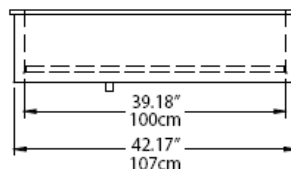
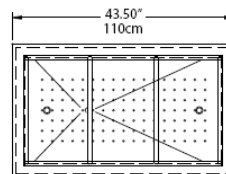

### Curved Models

#### Overall Dimensions:

ICPC-200: 21.80"Hx40.48"Wx26.05"D

ICPC-300: 21.80"Hx57.22"Wx26.05"D

ICPC-400: 21.80"Hx73.68"Wx26.05"D

ICPC-500: 21.80"Hx89.86"Wx26.05"D

#### Ship Weight:

ICPC-200: 100 LBS

ICPC-300: 118 LBS

ICPC-400: 145 LBS

ICPC-500: 164 LBS

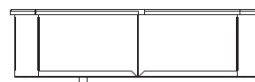
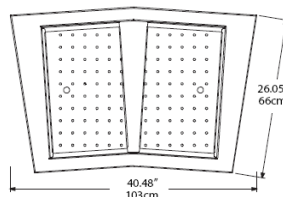

### Narrow Models

#### Overall Dimensions:

ICPN-200: 21-7/8"Hx32-13/16"W x 11-13/16"D

ICPN-300: 28"Hx46-1/8"W x 11-13/16"D

#### Ship Weight:

ICPN-200: 126 LBS

ICPN-300: 150 LBS

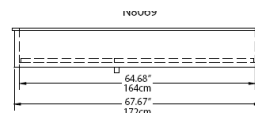
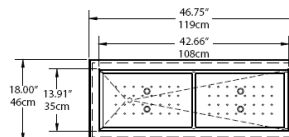

\*APW Wyott reserves the right to modify specifications or discontinue models without incurring obligation.