



JA4

(Shown with optional stand)



JA4SC

JET AIR OVEN (JA4 & JA4SC)

The JA Series from DOYON is known worldwide for its unique and patented JET AIR SYSTEM (the air moves in one direction for 2.5 minutes, stops for 25 seconds then moves the other way for 2.5 minutes) resulting in a gentle velocity air flow for exceptional baking results. This system will help you bake faster and more evenly without having to turn your pans at half of the baking time. (Ex: Competitors units will bake only one side or unevenly : muffins blow over, bakes only the outside, etc). Our competitors ovens allow the air to move in one direction only. DOYON ovens will bake better and your employees will continue preparations without worrying about turning pans.

DOYON's outstanding uniform steam injection system includes an electronic timer which will give you a precise mist everytime for a better quality product (crusty breads, bagels, french baguettes, etc.). This superior steam system will allow inexperienced employees to produce quality products with a minimum of training.

VERSATILITY:

Bread, rolls, buns, crusty breads, pastries, muffins, cookies, cakes, pies, bagels, croissants, sours and ryes, pizzas, hamburgers, bacon, game hens, chicken, turkey, multimeal prep, bulk vegetables/casseroles, slow cook/retherm.

JA4 & JA4SC

“Simply the **best**
bakery oven on
today's **market!**”

Jet Air Oven 4 pans baking capacity

OVEN FEATURING

- Countertop oven (JA4)
- Exclusive patented reversing fan system
- Outstanding steam injection system including an electronic timer
- Compact space saving unit
- High production oven (4 pans)
- Full view heat reflective thermos glass doors (single door available)
- Brightly lit
- Digital reminder timer
- Fully insulated, completely sealed
- Digital temperature controllers and timers
- Temperature up to a maximum of 500° F
- Energy efficient electric or gas heating (baking temperature reached in 15 minutes)
- Magnetic latches
- Door switch cut-off for fan blower
- Stainless steel inside and outside
- 3/4 HP motor
- Available gas (JA4SCG) or electric (JA4 & JA4SC)
- NSF & ETL listed
- One year parts and labor limited warranty

OPTIONAL

- Stand with locking casters (JA4B)
- Programmable controls
- Water softener system for installation
- Auto steam
- Delay switch (electric model only)

*All Jet Air ovens can
be used to cook meat*

OVERALL DIMENSIONS

JA4	32 1/2" W X 31" H	X 40 1/2" D
	(826 mm X 787 mm	X 1029 mm)
JA4SC	32 1/2" W X 71" H	X 37 1/4" D
	(826 mm X 1805 mm	X 946 mm)
JA4SCG	32 1/2" W X 71" H	X 43" D
	(826 mm X 1805 mm	X 1090 mm)

OVEN INTERIOR DIMENSIONS

JA4	27 1/2" W X 17 3/4" H	X 19 1/2" D
	(699 mm X 451 mm	X 495 mm)
JA4SC	27 1/2" W X 17 3/4" H	X 19 1/2" D
	(699 mm X 451 mm	X 495 mm)
JA4SCG	27 1/2" W X 17 3/4" H	X 18 1/2" D
	(699 mm X 451 mm	X 470 mm)

Shelf spacing 3 1/2" (89 mm)

GAS SYSTEM (JA4SCG - Propane or natural)

BTU total: 52 000

120V - 1 PH - 10 A - 1.2 kW - 2 wires - 60 Hz

NEMA 5-15P

Gas Inlet : 1/2" NPT

Draft hood : 6" (152 mm)

Recommended gas pressure:

Propane gas : 11" W.C.

Natural gas : 7" W.C.

ELECTRICAL SYSTEM (JA4 & JA4SC)

3 phases:

120/208V - 22A - 8 kW - 4 wires - 60 Hz

1 phase:

120/240V - 34A - 8 kW - 3 wires - 60 Hz

220V - 32A - 7 kW - 2 wires - 50 Hz

Other voltages available

Water Inlet : 1/4" NPT

OVEN CAPACITY

TOTAL

Standard sheet pans 18" X 26" (46 cm X 66 cm):

Four-strapped bread pans (up to 8 1/2" long):

9" (23 cm) pies:

4 pans

16 loaves

24 pies

FINISH

Stainless steel

SHIPPING INFORMATION

425 lb (193 kg) approximately (JA4)

650 lb (295 kg) approximately (JA4SC)

750 lb (341 kg) approximately (JA4SCG)

Electrical service connection and water inlet are located at the back of the unit.

Specifications and design subject to change without notice.

JA4

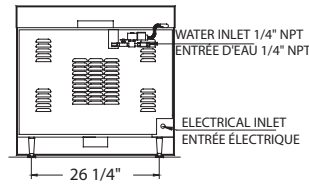
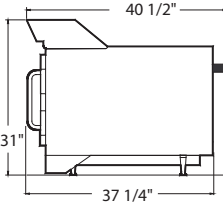
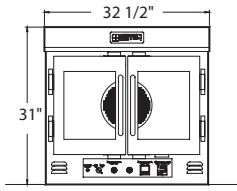

JA4SC

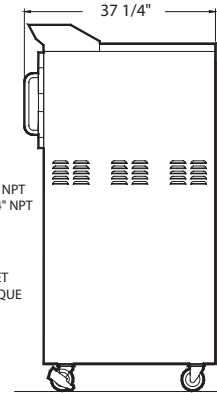
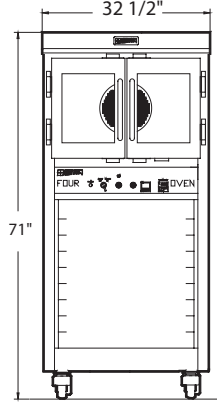

ELECTRICAL INLET
ENTRÉE ÉLECTRIQUE

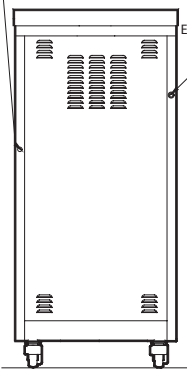

JA4SCG

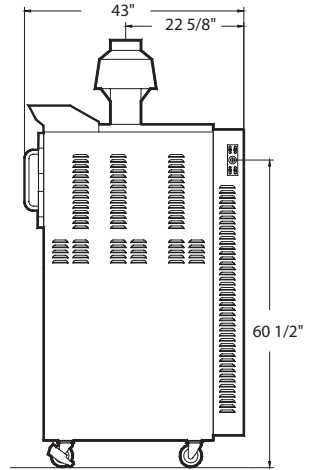
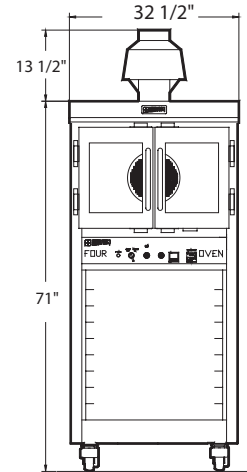

6" (15.2 cm) DRAFT HOOD
COUPE TIRAGE 6" (15.2 cm)

GAS INLET 1/2" NPT
ENTRÉE DE GAZ 1/2" NPT

WATER INLET 1/4" NPT
ENTRÉE D'EAU 1/4" NPT

ELECTRICAL INLET
ENTRÉE ÉLECTRIQUE

WATER INLET 1/4" NPT
ENTRÉE D'EAU 1/4" NPT

JA4B

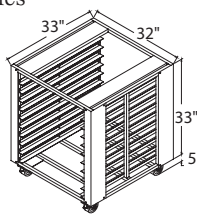

Your local distributor:

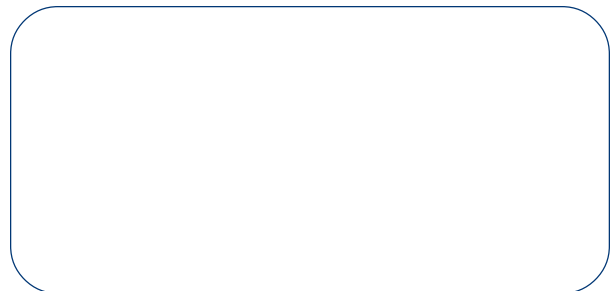

1255, rue Principale
Linière, Beauce, Québec, Canada G0M 1J0

Telephone: 418-685-3431
Canada: 1-800-463-1636
E-mail : doyon@doyon.qc.ca

Fax: 418-685-3948
U.S.: 1-800-463-4273
Internet : http://www.doyon.qc.ca