

**JAOP14**

**NEW**



JAOP14



EBake  
Standard  
control



Standard  
proofer control



Optional  
relative humidity proofer  
control

*“Superior quality product  
at an affordable price !”*

OVEN : 14 pans baking capacity  
PROOFER : 32 pans capacity

### Standard Features

- Outstanding steam shot and pulse injection system
- Exclusive patented reversing fan system
- Two speeds fan
- Fan delay switch
- Compact space saving unit
- High production oven
- Full view heat reflective thermos glass doors
- Brightly lit
- Manual mode and user friendly EBake programmable control up to 99 recipes
- Fully insulated, completely sealed
- Digital temperature controllers and timers
- Temperature up to a maximum of 500°F (260°C)
- Energy efficient electric or gas heating (baking temperature reached in 15 minutes)
- Magnetic latches
- Door switch cutoff for fan motor
- Stainless steel inside and outside
- Locking casters
- 3/4 HP motor
- ETL & NSF listed
- One year parts and labor limited warranty

### Proofer Features

- Holds from 90° F to 110° F (32°C to 43°C) with relative humidity up to 95 %
- Glass doors
- Rust proof, scratch proof shelving
- Automatic water float system (no water pans to fill)
- Brightly lit
- Magnetic latches
- Stainless steel inside and outside

### Optional

- Water softener system
- Gas quick disconnect kit (4' (1220 mm) flexible hose, ball valve and securing device)
- Electronic relative humidity control on proofer

## JET AIR OVEN PROOFER JAOP14

The JAOP series from Doyon is known worldwide for its unique and patented Jet Air System (the air moves in one direction for 2.5 minutes, stops for 25 seconds than moves the other way for 2.5 minutes) resulting in a gentle velocity air flow for exceptional baking results. This system will help you bake faster and more evenly. Our competitors ovens allow the air to move in one direction only.

Doyon's outstanding uniform steam injection system includes an electronic timer which will give you a precise mist everytime for a better quality product (crusty breads, bagels, french baguettes, etc.). This superior steam system will allow inexperienced employees to produce quality products with a minimum of training.

Doyon's proofer provides uniform proofing from top to bottom with its even air flow system and fully automatic humidity injection (no water pans to fill). It comes with heat and humidity controls. It's the easiest way to proof.

### VERSATILITY

Bread, rolls, buns, crusty breads, pastries, muffins, cakes, pies, bagels, croissants, sours & ryes, bacon, game hens, chicken, turkey, multimeal prep, bulk vegetables, casseroles, slow cook, retherm.

*All JAOP ovens can  
be used to cook meat*

**DIMENSIONS**

JAOP14	70"W	X 49 1/4"D	X 73"H
	(1778 mm)	X 1251 mm	X 1854 mm)
JAOP14G	70"W	X 53 5/8"D	X 73"H
	(1778 mm)	X 1362 mm	X 1854 mm)

**OVEN INTERIOR DIMENSIONS**

JAOP14	25 1/2"W	X 30 1/2"D	X 28" H
	(648 mm)	X 775 mm	X 711 mm)
JAOP14G	25 1/2"W	X 29 1/2"D	X 28" H
	(648 mm)	X 749 mm	X 711 mm)

Shelf spacing : 3 1/4" (83 mm)

**PROOFER INTERIOR DIMENSIONS**

26 1/4"W	X 36 1/2"D	X 55 1/2" H
(667 mm)	X 927 mm	X 1410 mm)

Shelf spacing : 3" (76 mm)

**GAS SYSTEM (JAOP14G Propane or natural)**

BTU total : 130 000 BTU  
 1 Phase:  
 208-240V - 21.5 A - 5.4 kW - 60 Hz - 2 wires + Ground

Gas Inlet : 1/2" NPT  
 Draft hood : 6" (152 mm)

Recommended gas pressure:  
 Propane gas : 11" W.C.  
 Natural gas : 7" W.C.

**ELECTRICAL SYSTEM (JAOP14)**

1 Phase:  
 208V - 117 A - 24.5 kW - 60 Hz - 2 wires + Ground  
 240V - 104 A - 24.5 kW - 60 Hz - 2 wires + Ground  
 3 Phases:  
 208V - 73 A - 24.5 kW - 60 Hz - 3 wires + Ground  
 240V - 65 A - 24.5 kW - 60 Hz - 3 wires + Ground  
 Other voltages available

Water Inlet : 1/4" NPT

Minimum clearance from combustible material  
 1" (25 mm) side and back  
 4" (102 mm) bottom  
 12" (305 mm) top

**CAPACITY**

Oven  
 Standard sheet pans 18" X 26" (457 mm X 660 mm) : 14 pans  
 Four-strap bread pans : 48 loaves  
 9" (229 mm) : 70 pies  
 Proofer  
 Standard sheet pans 18" X 26" (457 mm X 660 mm) :32 pans  
 Four-strap bread pans :120 loaves

**FINISH**  
 Stainless steel

**SHIPPING WEIGHT**

JAOP14 1700 lb (772 kg) approximately  
 JAOP14G 2000 lb (908 kg) approximately

Electrical service connection and water inlet are located at the back of the unit.  
 Specifications and design subject to change without notice.

**JAOP14**

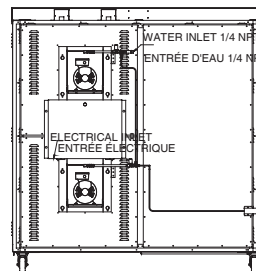
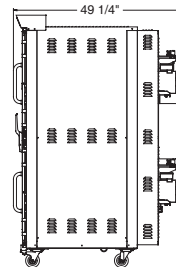
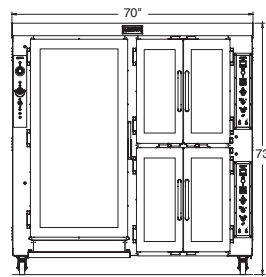

**JAOP14G**

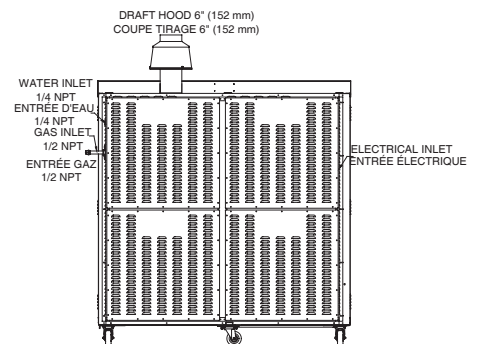
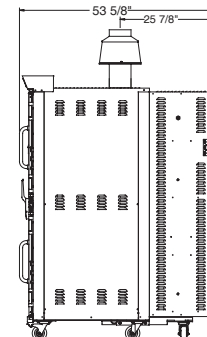
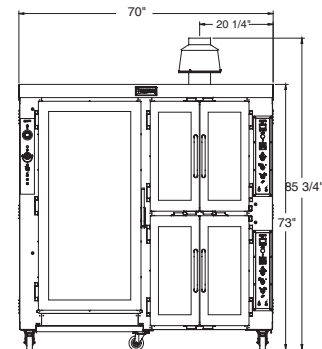

Your local distributor:

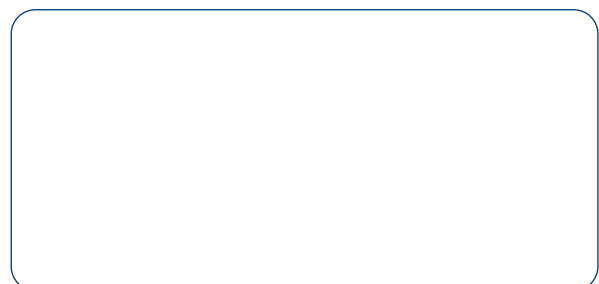

1255, rue Principale  
 Linière, Beauce, Québec, Canada G0M 1J0

Telephone : (418) 685-3431 Fax: (418) 685-3948  
 Canada : (800) 463-1636 U.S.: (800) 463-4273  
 E-Mail : doyon@doyon.qc.ca Internet: http://www.doyon.qc.ca