



# FLAV-R-SAVOR<sup>®</sup> HOLDING & DISPLAY CABINETS

Models FSD-1, FSD-1X, FSD-2, FSD-2X FSDT-1, FSDT-1X, FSDT-2, FSDT-2X

The Hatco Flav-R-Savor<sup>®</sup> offers a unique concept in food holding and display. Balancing a precise combination of heat and humidity, Flav-R-Savor cabinets increase sales and profits by reducing waste, maintaining quality, and displaying food with appealing design. Utilized in cafeterias, convenience stores, schools, restaurants, and supermarkets, Flav-R-Savor cabinets are a perfect way to merchandise your hot food items.

## FLEXIBILITY

A complete range of cabinet sizes, door options, and rack types allows for perfect merchandising of food products such as pizza, fried foods, bakery, and more.

Our quick recovery heating system and extremely even temperatures throughout the cabinet eliminate "hot spots" and ensure consistent product quality and long hold times (1 to 4 hours).

The *Designer* color option helps blend the cabinet into any décor and powdercoating provides a durable, easy-to-clean surface.

## QUALITY

The following features assure the finest performance for years to come:

- Fluorescent lights help showcase food product.
- Tempered glass door and side panels provide maximum heat retention and allow for full cabinet display.
- 1-gallon (4-liters) stainless water reservoir provides all day moisture, is easily filled through the front mounted water cup and easily drained and cleaned through the inside mounted drain tube.
- Low-water protection prevents heating element burnout and alerts operator to low water condition.
- 120-volt operation with attached 15-amp cord set operates on a standard outlet, and draws a maximum of 12 amps.
- Large access doors are field reversible and will accept a 19" (483 mm) diameter pizza pan.

## Single Door Models

- FSD-1 (Standard – with revolving rack)  
 FSD-1X (Standard – without revolving rack)  
 FSDT-1 (Tall – with revolving rack)  
 FSDT-1X (Tall – without revolving rack)

## Double Door Models

- FSD-2 (Standard – with revolving rack)  
 FSD-2X (Standard – without revolving rack)  
 FSDT-2 (Tall – with revolving rack)  
 FSDT-2X (Tall – without revolving rack)



Model FSDT-1X  
with 3-tier pan rack and accessory  
decals, food pans, and sign from  
[www.hatcographics.com](http://www.hatcographics.com)



## Custom Food Decals



Eye-catching food  
decals for the side  
panels. Maximum  
3 decals per unit.

Equipment  
On Signage Program  
[Hatcographics.com](http://Hatcographics.com)



Model FSDT-1  
with 4-tier circle rack  
and accessory pans

## Display Sign Holder and Sign



Sturdy metal sign holder mounts to the top of the cabinet using existing screws and includes a plexiglass window. Accessory PIZZA or CHICKEN sign maybe purchased separately. Up to three signs mount to each unit, adding 1" (25 mm) to its overall height.



ANSI/NSF 4

HATCO CORPORATION P.O. Box 340500 Milwaukee, WI 53234-0500 U.S.A.  
 (800) 558-0607 • (414) 671-6350 • Fax (800) 543-7521 • Int'l. Fax (414) 671-3976  
[www.hatcocorp.com](http://www.hatcocorp.com) • E-mail: [equipsales@hatcocorp.com](mailto:equipsales@hatcocorp.com)

ELEMENTS GUARANTEED AGAINST BURNOUT AND  
BREAKAGE FOR ONE YEAR.

Form No. FSD Spec Sheet

Printed in U.S.A.  
April 2012



# FLAV-R-SAVOR<sup>®</sup> HOLDING & DISPLAY CABINETS

Models FSD-1, FSD-1X, FSD-2, FSD-2X FSDT-1, FSDT-1X, FSDT-2, FSDT-2X

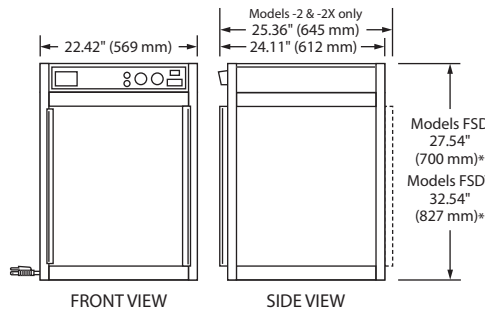

## DIMENSIONS

FSD-1, -1X: 22.42"W x 24.11"D x 27.54"H\* (569 x 612 x 700 mm).  
FSDT-1, -1X: 22.42"W x 24.11"D x 32.54"H\* (569 x 612 x 827 mm).  
FSD-2, -2X: 22.42"W x 25.36"D x 27.54"H\* (569 x 645 x 700 mm).  
FSDT-2, -2X: 22.42"W x 25.36"D x 32.54"H\* (569 x 645 x 827 mm).  
Cabinet Openings: FSD – 18.98"W x 18.73"H (482 x 476 mm).  
FSDT – 18.98"W x 23.73"H (482 x 603 mm).

\* Add 1" (25 mm) to height for display sign.

## VOLTAGE

120 volts, 60 Hz, 1440 watts,  
12.0 amps standard uses  
NEMA 5-15P. Export voltages  
available.

## CORD LOCATION

Facing controls, left-hand side panel, lower  
right corner.

## PLUG CONFIGURATIONS

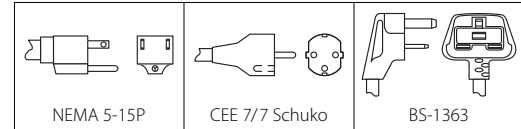

## SPECIFICATIONS

### Standard Models

Model*	Type	Rack Style†	Shipping Weight
FSD-1	1 Door	3-Tier Circle Rack w/Motor	113 lbs. (51 kg)
FSD-1X	1 Door	3-Tier Pan Rack w/o Motor	111 lbs. (50 kg)
FSD-2	2 Doors	3-Tier Circle Rack w/Motor	114 lbs. (52 kg)
FSD-2X	2 Doors	3-Tier Pan Rack w/o Motor	112 lbs. (51 kg)

### Tall Models

Model*	Type	Rack Style†	Shipping Weight
FSDT-1	1 Door	4-Tier Circle Rack w/Motor	120 lbs. (54 kg)
FSDT-1X	1 Door	4-Tier Pan Rack w/o Motor	118 lbs. (54 kg)
FSDT-2	2 Doors	4-Tier Circle Rack w/Motor	122 lbs. (55 kg)
FSDT-2X	2 Doors	4-Tier Pan Rack w/o Motor	120 lbs. (54 kg)

\* Models FSD-1, FSD-2, FSDT-1, and FSDT-2 include rack display motor. Models with "X" designator do not have revolving display.

† Rack shown is included with unit. Other racks available, see Display Rack Selection.

## WATER QUALITY REQUIREMENTS

Water supply in excess of 3.0 grains of hardness per gallon (GPG) (.75 grains of hardness per liter) must be treated and softened before being used. Water containing over 3.0 GPG (.75 GPL) will decrease the efficiency and reduce the operating life of the unit.

**Note: Product failure caused by liming or sediment buildup is not covered under warranty.**

## OPTIONS (NOT FOR RETROFIT)

- Designer Colors: Warm Red, Black, Gray Granite, White Granite, Navy Blue, Hunter Green, Antique Copper
- Mechanical Controls
- 7.5"H (191 mm) Merchandising Display Sign Holder with Acrylic Window (one per side) (sign not included)

## ACCESSORIES

- 4" (102 mm) Adjustable Legs
  - Motorless Rack Coupling (For -X Models only)
  - Racks – **FSD ONLY**
    - 5-Shelf Multi-Purpose Rack Model FSD5SMP
    - 3-Tier Circle Rack Model FSD3TCR\*
    - 3-Tier Pan Rack Model FSD3TPR
  - Racks – **FSDT ONLY**
    - 7-Shelf Multi-Purpose Rack Model FSDT7SMP
    - 4-Tier Circle Rack Model FSDT4TCR\*
    - 5-Tier Circle Rack Model FSDT5TCR\*
    - 4-Tier Pan Rack Model FSDT4TPR
    - 3-Shelf Angle Rack Model FSDT3SAR
    - 5-Shelf Angle Rack Model FSDT5SAR
    - 3-Tier Pretzel Tree Model FSDT3TPT\*
    - Merchandising Display Sign Holder with Acrylic Window
  - Merchandising Display Sign: Pizza or Chicken
  - Food Graphic Adhesive Decals (3 per set): Pizza, Chicken, Pretzel, or Croissants/Biscuits
  - Perforated Pizza Pans – 14", 15", 16", or 18" (356, 381, 406, 457 mm) Diameter
  - Half-size Sheet Pan
- \*Requires coupling for -1X or -2X

## Display Rack Selection

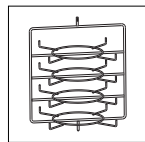

**3-Tier Circle Rack Model FSD3TCR**  
Rack Opening:  
4.63" (118 mm)



**4-Tier Circle Rack Model FSDT4TCR**  
Rack Opening:  
4.63" (118 mm)

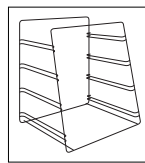

**3-Tier Pan Rack\* Model FSD3TPR**  
Rack Opening:  
3.5" (89 mm)

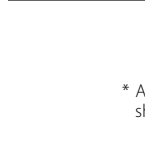

**4-Tier Pan Rack\* Model FSDT4TPR**  
Rack Opening:  
3.5" (89 mm)

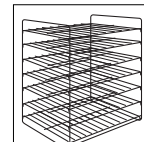

**5-Shelf Multi-Purpose Rack Model FSD5SMP**  
Rack Opening:  
2.5" (64 mm)

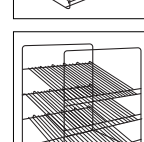

**7-Shelf Multi-Purpose Rack Model FSDT7SMP**  
Rack Opening:  
2.5" (64 mm)

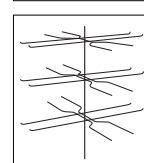

**3-Shelf Angle Rack Model FSDT3SAR**  
Rack Opening:  
3.5" (89 mm)  
Rack shelves slant at 15° angle

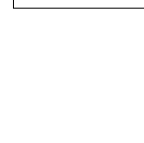

**3-Tier Pretzel Tree Model FSDT3TPT**  
Rack Opening:  
5.88" (150 mm)

\* Accommodates half-size sheet pans (not included).

## PRODUCT SPECS

### Holding and Display Cabinet

The humidity controlled Holding and Display Cabinet shall be a Flav-R-Savor<sup>®</sup> Model ..., rated at ... volts and ... watts, as manufactured by the Hatco Corporation, Milwaukee, WI 53234 U.S.A.

With 24/7 parts and service assistance (U.S. and Canada only), the cabinet shall have ... door(s), tempered glass sides, stationary rack (or revolving display),

and fluorescent display lights. It shall include a water reservoir, humidity selector switch, temperature selector dial, on-off switch, indicating lights, and a 6' (1829 mm) cord with plug attached.

Accessories shall include adjustable legs, display racks, pans, merchandising display sign(s), and food graphic decals.

HATCO CORPORATION P.O. Box 340500 Milwaukee, WI 53234-0500 U.S.A. • (800) 558-0607 • (414) 671-6350  
Fax (800) 543-7521 • Int'l. Fax (414) 671-3976 • www.hatcocorp.com • E-mail: equipsales@hatcocorp.com