

This Space for Architect/Engineer Approval

Job Name _____ Date _____

Model Specified _____ Quantity _____

Customer/Wholesaler _____

Contractor _____

Architect/Engineer _____

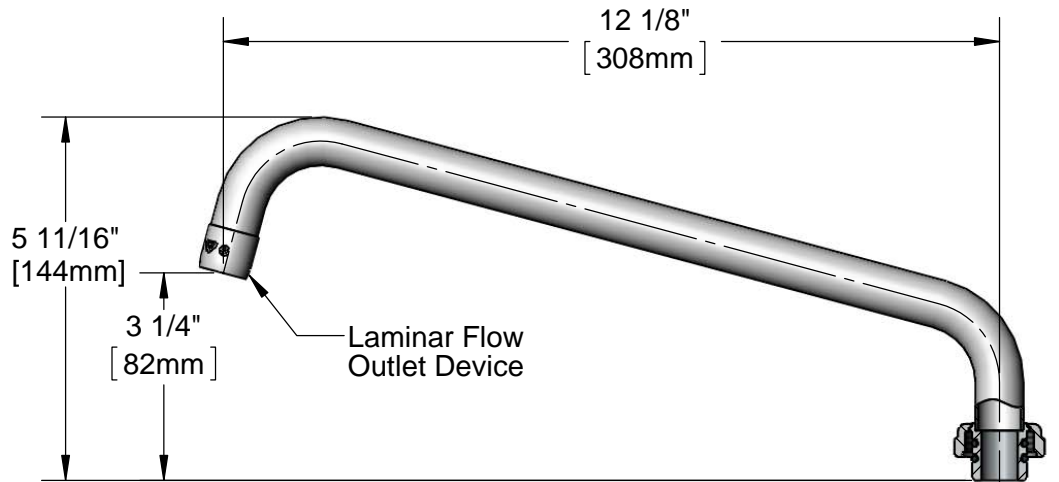
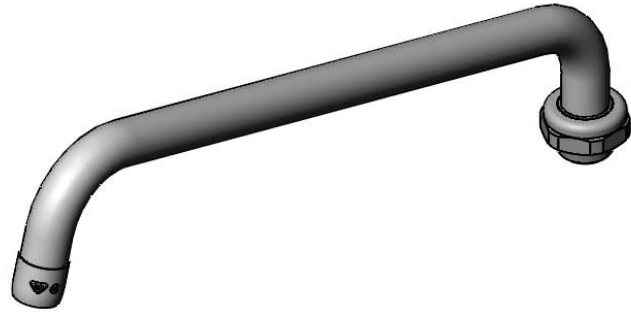

Note:
Conversion to Rigid Requires 014200-45 Lock Washer
(Available Separately)

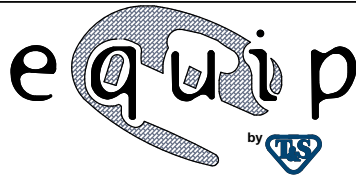
<p>Model Number</p> <p style="text-align: center;">5SP-12</p>	<p>Product Specifications:</p> <p style="text-align: center;">12" Swing Nozzle w/ Laminar Flow Device</p>				
<p>Product Compliance:</p> <p>ASME A112.18.1 / CSA B125.1 NSF 61 - Section 9 NSF 372 (Low Lead Content)</p>	<div style="display: flex; justify-content: space-between; align-items: center;"> <div data-bbox="600 1906 738 1980"> <p>equip Foodservice Accessories</p> </div> <div data-bbox="743 1858 1096 2032">  </div> <div data-bbox="1101 1896 1550 1997"> <p>2 Saddleback Cove, P.O. Box 1088 Travelers Rest, South Carolina 29690 Phone: 800.891.4808 Fax: 800.868.0084 equip.tsbrass.com</p> </div> </div>				
<p>Drawn: JBC</p>	<p>Checked: JRM</p>	<p>Approved: JHB</p>	<p>Date: 11/21/16</p>	<p>Scale: 1:3</p>	<p>Sheet: 1 of 1</p>