



T&S BRASS AND BRONZE WORKS, INC.

2 Saddleback Cove / P.O. Box 1088
Travelers Rest, SC 29690

Model No.

B-0316

Item No.

Travelers Rest, SC: 800-476-4103 • Simi Valley, CA: 800-423-0150 • Fax: 864-834-3518 • www.tsbrass.com

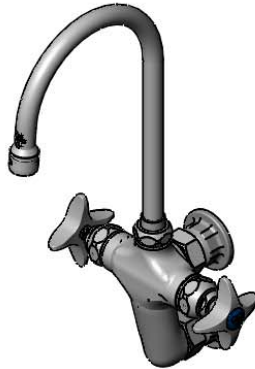
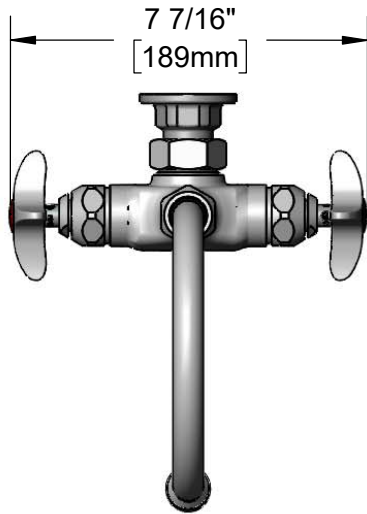

This Space for Architect/Engineer Approval

Job Name _____ Date _____

Model Specified _____ Quantity _____

Customer/Wholesaler _____

Contractor _____

Architect/Engineer _____



ADA Compliant

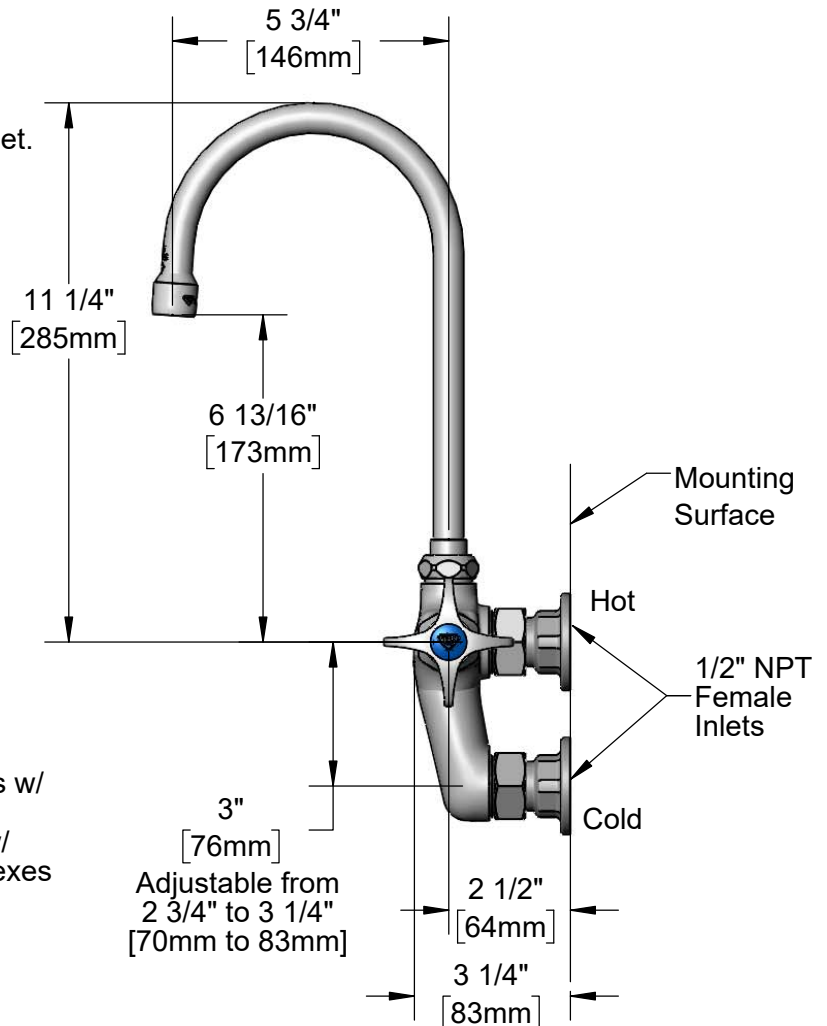
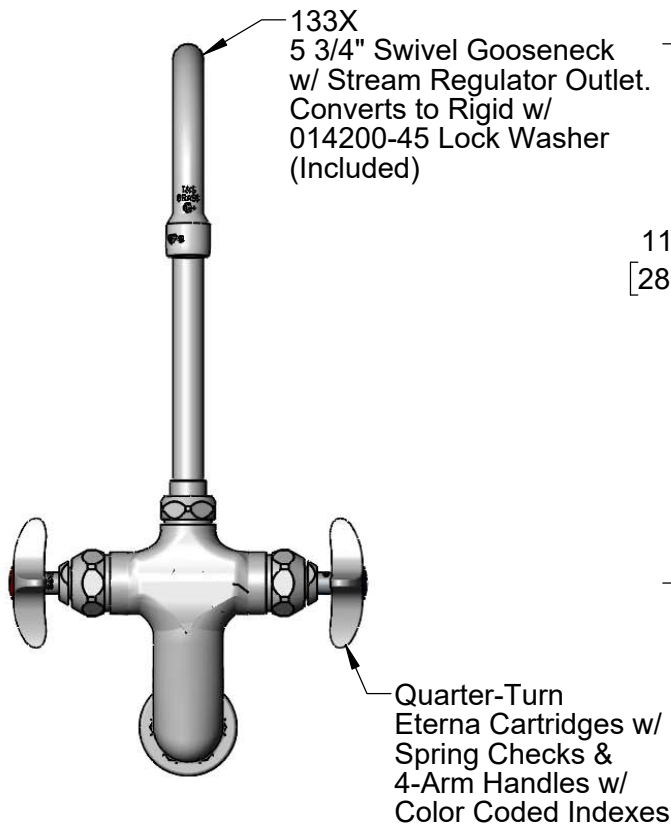

Product Specifications:

Wall Mount Vertical Mixing Faucet, 5 3/4" Swivel Gooseneck w/ Stream Regulator Outlet, 4-Arm Handles and 1/2" NPT Female Inlets

Product Compliance:

ASME A112.18.1 / CSA B125.1
NSF 61 - Section 9
NSF 372 (Low Lead Content)
ANSI A117.1 (ADA)



T&S BRASS AND BRONZE WORKS, INC.
 2 Saddleback Cove / P.O. Box 1088
 Travelers Rest, SC 29690

Model No.
B-0316
 Item No.

Travelers Rest, SC: 800-476-4103 • Simi Valley, CA: 800-423-0150 • Fax: 864-834-3518 • www.tsbrass.com

ITEM NO.	SALES NO.	DESCRIPTION
1	B-PT	Full Flow Stream Regulator, 55/64-27
2	133X	5 3/4" Swivel Gooseneck w/ Stream Regulator Outlet
3	009538-45	Swivel Washer
4	011429-45	Swivel Sleeves (2)
5	001074-45	O-Ring
6	014200-45	Star Washer, Anti-Rotation
7	001019-45	Coupling Nut Washer
8	00AA	1/2" NPT Female Eccentric Flange
9	012443-40NS	Quarter-Turn Eterna Cartridge w/ Spring Check, RTC
10	000925-45	Lab Handle Screw
11	018506-19NS	Blue Button Index, Press-in
12	002521-45NS	4-Arm Handle (New Style)
13	001193-19NS	Red Button Index, Press-in

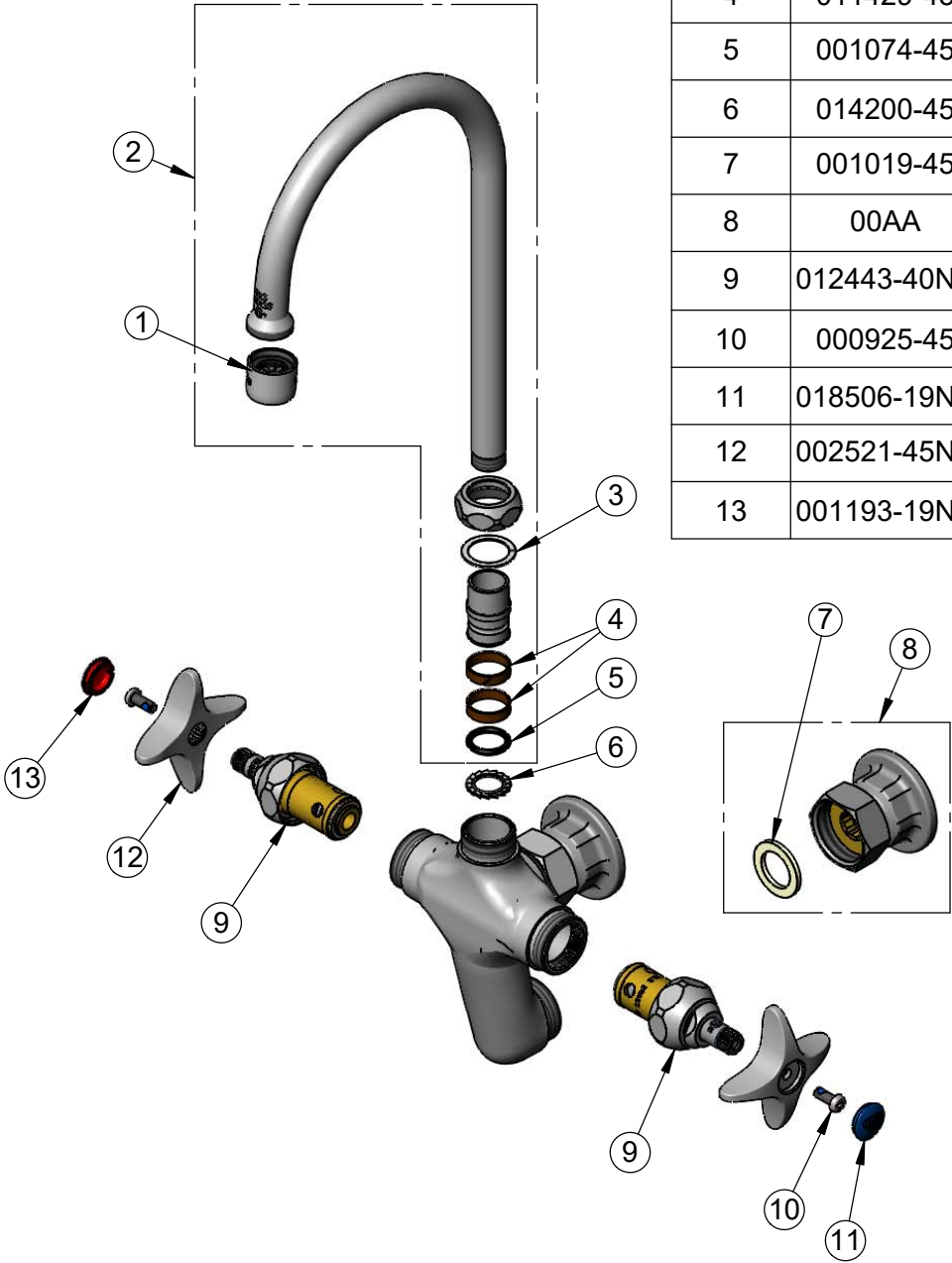

Product Specifications:
 Wall Mount Vertical Mixing Faucet, 5 3/4" Swivel Gooseneck w/ Stream Regulator Outlet, 4-Arm Handles and 1/2" NPT Female Inlets

Product Compliance:
 ASME A112.18.1 / CSA B125.1
 NSF 61 - Section 9
 NSF 372 (Low Lead Content)
 ANSI A117.1 (ADA)