

Standard Features

- 287 racks per hour hi-temp sanitizing rinse.
- 0.77 gallons per rack hi-temp sanitizing rinse.
- Incoming water pressure regulator
- Exclusive Adjust-A-Peak feature (patented) allows the owner operator to manually adjust the speed of the conveyor system from 144 racks per hour all the way to maximum capacity of 287 racks per hour.
- Standard 25" clearance allows owner operators the ability to wash large utensils, trays, and bun pans.
- Totally electro-mechanical; no solid state controls utilized.
- Fully automatic including auto-fill.
- Completely self draining, stainless steel prewash, wash, and recirculating rinse pumps.
- Exclusive "Energy Guard" controls system energizes prewash, wash, recirculating rinse, and final rinse sections only when a rack is in place.
- Convenient, externally operated lever drains.
- Stainless steel frame, legs, adjustable bullet feet, and front appearance panel are all standard.
- Standard 8" vent cowls/splash shields on both wash and rinse ends of the machine.
- Heavy gauge construction for extra ruggedness and durability.

Power/Connections

Approximate Total Load	AMPS
208V / 60HZ / 3PH	87.4
208V / 60HZ / 1PH	147.4
230V / 60HZ / 3PH	80.7
230V / 60HZ / 1PH	136.0
460V / 60HZ / 3PH	40.4

Booster Heater Options

External 40°F Min. Rise	KW	AMPS
208V / 60HZ / 3PH	34.5	95.8
230V / 60HZ / 3PH	36	90.5
460V / 60HZ / 3PH	36	45.2

External 70°F Min. Rise	KW	AMPS
208V / 60HZ / 3 PH	45	125.0
230V / 60HZ / 3PH	45	108.0
460V / 60HZ / 3PH	45	54.0

Venting Requirements (CFM)

Input end	200
Output end	400
Total CFM	600

Water Requirements

Incoming Prewash Tank Temperature(°F)	110-140
Incoming Water Temperature (°F)	180
With 35 KW booster heater option (°F)	140
With 45 KW booster heater option (°F)	110
Gallons per hour	222
Gallons per rack	0.77
Prewash Tank Capacity (Gallons)	16
Wash Tank Capacity (Gallons)	15.4
Power Rinse Tank Capacity (Gallons)	15.4
Incoming Waterline Size (IPS) (Minimum)	
Prewash Tank Fill	3/4
Wash Tank / Rinse Tank / Final Rinse	3/4
Flow Pressure (PSI)	15-25
Flow Rate Minimum (GPM)	3.7
Drainline Size IPS (Minimum) (Inches)	1 1/2

Performance/Capacities

Operating Capacity

Racks per hour	287
Dishes per hour	7175
Glasses per hour	7175

Steam Coil Tank Heat

Steam Connection IPS (Inches)	3/4
Steam Flow Pressure (PSIG)	10-20
Consumption @ 15 PSIG (Lbs/hr)	100

Prewash Pump Motor HP	2
Wash Pump Motor HP	2
Wash Pump Capacity (GPM)	270
Wash Tank KW	10
Power Rinse Pump Motor HP	2
Power Rinse Pump Capacity (GPM)	270
Power Rinse Tank KW	15

Conveyor Motor Horsepower	1/4
Conveyor Speed (Feet/minute)	8.0

Operating Temperatures

Prewash Tank-°F	110-140
Wash Tank-°F (Minimum)	150
Power Rinse Tank-°F (Minimum)	160
Final Rinse-°F (Minimum)	180

Dimensions (Inches)

Length between dishtables	100
Machine width	25
Wall Clearance (Minimum)	4.5
Cavity/dish clearance (Maximum)	25

Shipping Information

Weight (Lbs)	1150
Dimensions (Inches)	
Length	120
Depth	40
Height	78
Volume (Cubic feet)	217.0

Specifications

NOTE: The AJ-100 series conveyor dishmachines are listed by the National Sanitation Foundation (NSF), Underwriters Laboratories Inc. (UL), and by the Canadian Standards Association (CSA). They also meet the requirements of A.S.S.E. Standard No. 1004.

PERFORMANCE: Fully automatic, multiple tank, rack conveyor dishwasher with a recirculating prewash designed to prewash, wash, rinse, and sanitize tableware and utensils commonly associated with the preparation and consumption of food items in a commercial foodservice operation. Sanitization is accomplished through hi-temp sanitization utilizing 180-195°F fresh water rinse. The unit conveys standard 20" x 20" dishracks through a recirculating prewash section where 270 gallons per minute (GPM) of 110-140°F water is pumped over the rack to mechanically prepare the ware for washing. Next, the rack is conveyor driven into a detergent laden wash section where 270 gallons per minute of 150°F wash water is pumped over the dishrack to remove the food soil. It then enters the power rinse section where a recirculating rinse of 160°F water at 270 GPM is pumped over the dishrack. Finally, the rack is conveyor driven into a final rinse section where a fresh water final rinse spray system removes remaining residual detergent and sanitizes. The unit must be connected to a potable water line capable of supplying 222 gallons per hour between 180-195°F at 15-25 PSI flow pressure for maximum hourly rack capacity of 287 racks per hour.

CONSTRUCTION: All stainless steel components are 304 series stainless steel. No. 400 series stainless steel and/or plastics are utilized. Frame is constructed of 2" diameter stainless steel tubing formed and completely saddle welded for superior strength. The prewash tank, wash tank, recirculating rinse tank, and final rinse chamber are formed and heliarc welded 16 gauge #2B finish. Hood is 16 gauge #3 finish. Stainless steel feet are adjustable $\pm 1/2"$.

PREWASH PUMP: Internal prewash pump located inside the prewash tub is totally stainless steel as is the impeller. The pump is integral with the motor and self-draining. Prewash water is recirculated from the prewash tank through the manifolds and prewash arms system at the rate of 270 GPM.

PREWASH PUMP MOTOR: A 2 HP totally enclosed, fan cooled type motor drives the prewash pump. Single-phase motors are capacitor start, induction run with internal thermal overload protection. Three-phase motors are induction run with external overload protection. Motor shaft is supported by permanently lubricated grease packed ball bearings.

WASH PUMP: Internal wash pump located inside the wash tub is totally stainless steel as is the impeller. The pump is integral with the motor and self-draining. Wash water is recirculated from the wash tank through the manifolds and wash arm system at the rate of 270 GPM.

WASH PUMP MOTOR: A 2 HP totally enclosed, fan cooled type motor drives the wash pump. Single-phase motors are capacitor start, induction run with

internal thermal overload protection. Three-phase motors are induction run with external overload protection. Motor shaft is supported by permanently lubricated grease packed ball bearings.

POWER RINSE PUMP: Internal power rinse pump located inside the wash tub is totally stainless steel as is the impeller. The power rinse pump is integral with the motor and self-draining. Wash water is recirculated from the power rinse tank through the manifolds and wash arm system at the rate of 270 GPM.

POWER RINSE PUMP MOTOR: A 2 HP totally enclosed, fan cooled type motor drives the wash pump. Single-phase motors are capacitor start, induction run with internal thermal overload protection. Three-phase motors are induction run with external overload protection. Motor shaft is supported by permanently lubricated grease packed ball bearings.

CONVEYOR SYSTEM: Racks are conveyed through the machine by a center-mounted, heavy-duty stainless steel pawl bar with stainless steel cast, counterweighted, wide surface pawls. The pawl bar is designed not to interfere with spray patterns in the prewash, wash, recirculating rinse and final rinse section. The pawl bar is driven by a 1/4 HP motor and worm drive gear reduction unit. The conveyor motor itself is totally enclosed, non-ventilated. Single-phase motors are capacitor start, induction run with internal thermal overload protection. Three-phase motors are induction run with external overload protection. Pawl bar conveyor drive unit is mounted on the left hand side of the machine and is enclosed with a removable stainless steel cover. Maximum conveyor speed is 8.0 feet per minute.

ADJUST-A-PEAK: The Adjust-A-Peak feature is a mechanical feature located on the pawl bar drive unit itself and allows the end-user to slow down the speed of the conveyor drive unit when enhanced results are required (i.e. baked-on food soil) or increase the speed of the conveyor drive unit when maximum capacity is required. By slowing down the conveyor, a rack of tableware remains in the prewash, wash, and rinse sections for longer periods of time. When soil loads are heavy (i.e. pots and pans, trays, and bun pans), adjusting the conveyor to slower speeds means outstanding results.

CHAMBER: The chamber has a standard clearance of 25" which is the highest clearance in the industry—even higher than competitive higher hood options. This adds to the versatility of the machine since you can easily accommodate larger utensils such as sheet pans and 60 quart mixing bowls. The combination of a higher hood in conjunction with manually slowing down the conveyor utilizing the Adjust-A-Peak feature produces superior results as well as adding to the versatility of the machine.

CONTROLS: Controls are located in a stainless steel control box mounted on top of the machine for ease of access and increased reliability. Power "ON/OFF" switch is the only manual switch required. "Energy Guard" fully automates the machine and utilizes switching logic to operate prewash, wash, recirculating rinse and final rinse sections only when a rack is in place as well as turning the conveyor off when a rack exits the machine and there

are no other racks in the machine. Regardless of machine voltage, all control circuitry will be operated from a 110 volt control circuit transformer. Again, the Adjust-A-Peak feature eliminates the need for manual controls since you have the ability to slow down the conveyor for extended prewash, wash, recirculating rinse, and final rinse contact time. The unit is completely wired with 105°C, 600V thermoplastic insulated wire and routed through UL approved conduit. The control circuit itself is protected by a manual reset 1 AMP overload protector located on the front of the control box.

FILL: Initial fill of the prewash, wash and power rinse tanks are automatic when machine is initially energized. There is a fill line to the wash and power rinse tanks and a separate fill to the prewash tank. Each fill line is controlled by its own solenoid valve and vacuum breaker assembly. The prewash tank needs to be hooked up to a water line capable of filling with 110-140°F incoming potable water. If the cold water thermostat option is utilized in the prewash, an additional cold water line needs to be hooked up to the machine. The wash tank and power rinse tank fill line needs to be hooked up to a 180°F minimum incoming potable water line which normally would be supplied by an external booster heater or our own optional Hatco booster heater packages. The fill solenoids for both tanks are activated by stainless steel float systems located in the individual tanks for required tank water levels.

RECIRCULATING PREWASH: The prewash tank has a 16.0 gallon capacity and maintains that level with a skimming type overflow. Prewashing action is accomplished by recirculating 110-140°F water through 20 separate stripping nozzles through three upper arms and two lower arms. This superior action removes heavy soil and deposits it in a large outside deep well scrap basket located on the front of the machine for easy access. A secondary removable pump intake strainer protects the pump. Make-up water comes from the wash tank at the rate of approximately 2 GPM. All five prewash arms are easily removable and along with removable end caps, are easily cleanable without the use of tools.

RECIRCULATING WASH: The wash tank has a 15.4 gallon capacity and maintains that level with a skimming type overflow. Washing action is accomplished by recirculating detergent laden water in the wash tank through upper and lower wash arms. Make-up water comes from the power rinse section and is controlled at approximately 2 GPM. The wash arms are 18" long. Wash section is automatically activated by racks as they pass through. Wash arms, upper and lower, contain 43 separate stripping nozzles for superior performance. Both wash arms are easily removable and along with removable wash arm end caps, are easily cleanable without the use of tools. Large stainless steel strainer pans, as well as a pump intake strainer for secondary protection are readily accessible and removable for cleaning purposes. Knockouts and connections are provided to allow easy installation of detergent concentration sensor and dispenser tubing by others.

POWER RINSE: The power rinse tank has a 15.4 gallon capacity and maintains that level with a skimming type overflow. Rinsing action is accomplished by recirculating final rinse water in the tank through upper and lower wash arms. Make-up water comes from the final rinse section and is controlled at approximately 2 GPM. The arms are 12" long. The power rinse section is automatically activated by racks as they pass through. Power rinse arms, upper and lower, contain 32 separate stripping nozzles for superior performance. Both power rinse arms are easily removable and along with removable wash arm end caps, are easily cleanable without the use of tools. Large stainless steel strainer pans, as well as a pump intake strainer for secondary protection are readily accessible and removable for cleaning purposes.

FINAL RINSE: Fresh pressurized rinse water enters the machine through a standard "Y" strainer, solenoid valve, and approved vacuum breaker assembly which is plumbed to upper and lower final rinse arms located at the output end of the machine. A single row of fan jet nozzles are located on both rinse arms. Connection point is provided for rinse agent injection into the final rinse line by others. Total final rinse flow rate is 3.7 GPM.

DRAIN, OVERFLOW, AND MAKE-UP: The machine is designed to maintain appropriate prewash, wash, and power rinse tank water levels at all times even at low pressures. The overflow system is designed to automatically skim the surface of the prewash, wash, and power rinse tanks. Make-up water from the final rinse replenishes the power rinse tank which replenishes the wash tank, which in turn replenishes the prewash tank as well as maintains appropriate water levels and temperatures. Large levers located on the front panel of the machine operate valves that drain the machine completely.

PRESSURE REDUCING VALVE: Factory installed on incoming water line to control water pressure.

Additional Standard Equipment:

- Vent cowls/splash shields with 4" x 16" openings covered with removable plates for connection to exhaust ducts when required.
- Flexible strip curtains provided at the ends of the vent cowls as well as at the ends of the machine and separating the prewash, wash, power rinse, and final rinse sections.
- Extra large inspection doors located on front of machine for easy access and cleanability.
- Safety door switches shut down machine should any door be opened during operation.
- Stainless steel front appearance panel.
- Positive low level water protection for wash and power rinse tank heat.
- Sealed dial type thermometers for the prewash, wash, power rinse and final rinse temperatures.

Optional Mandatory Specifications:

WASH TANK HEATING EQUIPMENT (CHOOSE ONE):

ELECTRIC: Low watt density 25 KW tubular heating elements mounted inside the tanks (10 KW wash and 15 KW power rinse) and easily removable from the outside. The heaters are protected by a stainless steel float system as well as high limit overload protection. Water temperature in the tanks is controlled and maintained by fast reacting thermostats which control the heating elements.

STEAM: Stainless steel coils are utilized rather than injectors so that contaminated steam being injected into the wash water is not an issue. Stainless steel tubular steam coils are mounted inside the wash and power rinse tanks below the optimum water level. The coils are protected by a stainless steel float system. An external steam "Y" strainer and high temperature steam solenoid regulates the flow of steam through the coils. Temperature in the tanks is controlled and maintained by fast reacting thermostats which control the operation of the steam solenoids. A float and thermostatic steam trap is provided and removes steam condensate from the steam coils which can either be plumbed to a drain or pumped back to the boiler if a condensate return system is available. Steam coils require a minimum of 10 PSIG flowing steam supply and a maximum of 20 PSIG. Install with a steam pressure regulator (by others) if steam supply exceeds 20 PSIG.

Optional Features and Accessories:

EXTERNAL ELECTRIC BOOSTER HEATER: External 36 KW Hatco booster heater boosts incoming 140°F water to a minimum of 180°F for hi-temp sanitizing rinse. Custom features include castone-lined tank, low water cutoff, pressure relief valve, as well as a pressure reducing valve. Unit is located next to the output end of the machine, completely preplumbed. Power to the booster heater requires a separate electrical connection. Unless specified otherwise, electrical characteristics of the booster heater will be the same as that of the dishwasher. The booster heater is approximately 36 KW and is available in 208/240/480 voltages/3 phase only.

EXTERNAL 70°F RISE BOOSTER HEATER: External 45 KW Hatco booster heater capable of boosting incoming 110°F water a minimum of 70 degrees to a minimum of 180°F for hi-temp sanitizing rinse. Unit is located next to the output end of the machine and comes completely preplumbed. Power to the booster heater requires a separate electrical connection. Unless specified otherwise, electrical characteristics of the booster heater will be the same as that of the dishwasher. The booster heater is available in 208/240/480 voltages/3 phase only.

STEAM BOOSTER HEATER: Sized to be connected to a standard 140°F incoming water supply in order to insure 180-195°F hi-temp sanitizing final rinse requirements. Unit comes complete with steam "Y" strainer and high temperature steam solenoid as well as a steam pressure relief valve. Water temperature is controlled and maintained by a fast reacting thermostat which controls the operation of the steam solenoid. A float and thermostatic steam trap is provided and removes steam condensate from the coil which can either be plumbed to a drain or pumped back to a boiler if a condensate return system is available. Must be installed with a steam pressure regulator (by others) if steam supply exceeds 20 PSIG.

TABLE LIMIT SWITCH: Factory wired to machine and mounted to the backsplash of the table in the field. Prevents damage to conveyor drive system, racks, and dishes due to racks backing up on the output end of the machine. Highly recommended for clean dishtables less than 10 feet in length.

VENT COWL COLLARS: Factory installed 4" x 16" x 7" high collars located on the vent cowls to allow easy connection to an external exhaust system including a standard "pant-leg" type exhaust duct. Includes adjustable and lockable damper flap for fine tuning exhaust system to remove appropriate CFM requirements.

50 CYCLE (HERTZ) ELECTRICAL CHARACTERISTICS: Units are available in 50 HZ in the following voltages: 208V/1 or 3PH, 230V/1 or 3PH, 380V/3PH, and 460V/3PH. Units operating at 50 HZ are not submitted for UL Listing.

SIDELoader: Factory installed option on input end of conveyor machine. This feature allows the machine to be installed close to a corner and maximize dishroom space. The sideloader option is available in both the hooded and unhooded versions. See separate spec sheets for details.

EXHAUST VENT FAN CONTROL: Automatically turns exhaust vent fan on when rack enters the machine. Delay timer also turns off the exhaust vent fan 5-10 seconds after rack exits machine when no other racks are being conveyed through the machine.

FLANGED FEET: Available for installations where permanent mounting to the floor is required. Fully adjustable for required height.

WATER HAMMER ARRESTOR: Installed inside the supply line.

AJ-100 Vision Series

Conveyors

Specifications

Note: Check and/or copy all that apply.

AJ-100 SERIES RACK CONVEYOR DISHWASHER – ITEM NO.

Shall be a Jackson AJ-100 Series, multiple tank rack conveyor dishwasher. Sanitization shall be accomplished by using a hi-temp (180°F minimum) rinse.

Electrical characteristics shall be:

_____ 208V/60HZ/3PH _____ 208V/50HZ/3PH
_____ 208V/60HZ/1PH _____ 208V/50HZ/1PH
_____ 230V/60HZ/3PH _____ 230V/50HZ/3PH
_____ 230V/60HZ/1PH _____ 230V/50HZ/1PH
_____ 460V/60HZ/3PH

Wash tank heating shall be a minimum of 150°F for hi-temp applications and accomplished by:

_____ 10 KW electric heating elements thermostatically controlled.
_____ Stainless steel steam coils thermostatically controlled.

Power rinse tank heating shall be a minimum of 160°F for hi-temp applications and accomplished by:

_____ 15 KW electric heating elements thermostatically controlled.
_____ Stainless steel steam coils thermostatically controlled.

Direction of rack flow shall be (when standing in front of machine):

_____ Right-to-Left _____ Left-to-Right

Unit shall have the following features as optional extras:

_____ External Hatco 36 KW booster heater for a minimum 40°F rise and available in the following voltages:

_____ 208V/50 or 60HZ/3PH
_____ 240V/50 or 60HZ/3PH
_____ 480V/50 or 60HZ/3PH

_____ External Hatco 45 KW booster heater for a minimum 70°F rise and available in the following voltages:

_____ 208V/50 or 60HZ/3PH
_____ 240V/50 or 60HZ/3PH
_____ 480V/50 or 60HZ/3PH

_____ Steam booster heater.

_____ Table limit switch completely prewired and extending from the output end of the machine, available in 9'0" length.

Unit shall have the following features:

- Capacity of 287 racks per hour utilizing 0.77 gallons of water per rack for hi-temp sanitizing rinse.
- Incoming water pressure regulator
- Adjust-A-Peak conveyor drive system to manually adjust rack capacity of the machine.
- Minimum 25" clearance throughout machine.
- Exclusive "Energy Guard" controls system energizes prewash, wash, recirculating rinse, and final rinse sections only when a rack is in place.
- Completely electro-mechanical; no solid-state controls.
- Fully automatic operation including auto-fill.
- Prewash section shall have three upper arms and two lower arms.
- Completely self draining, stainless steel prewash, wash, and recirculating rinse pumps.
- Convenient, externally operated lever drains.
- Vent cowls/splash shields with extra curtains on both wash and rinse ends of the machine.
- Stainless steel frame, legs, adjustable bullet feet, and front appearance panel.
- All 304 series stainless steel construction; no. 400 series stainless steel and no plastics utilized.

_____ Table limit switch completely prewired and extending from the output end of the machine, available in 12'0" length.

_____ Table limit switch completely prewired and extending from the output end of the machine, available in 15'0" length.

_____ Installed 4" x 16" x 7" high vent cowl collars for easy connection to an external exhaust system and including adjustable and lockable damper flaps.

_____ output end only _____ input end only
_____ both ends

_____ Incoming water hammer arrestor(s) completely installed.

_____ Sideloader installed on input end of machine.

_____ unhooded sideloader _____ hooded sideloader

_____ Exhaust fan control controls external exhaust fan power and duration time.

_____ Flanged feet for permanent in-place mounting to the floor.



www.jacksonmsc.com
1-888-800-5672



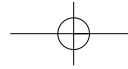

AJ-100 Vision Series



Left to Right Operation Shown

Legend to Drawing

- A** - Electrical Connection- See Table for Amperage Requirements
- B** - Water Inlet- 3/4" I.P.S., 180°F Water Required
- C** - Water Inlet- 3/4" I.P.S., 140°F Water Required
- D** - Drain Connection- 1 1/2" I.P.S.
Vent Collar/Splash Shield
- F** - Vent Collar with Damper 4" w. x 16"lg x 7"high- **Optional**
- G** - Steam Connection- 1" I.P.S.
- H** - Condensate Return- 1" I.P.S.

Approximate Total Load Amperes

Power Supply	AJ100CE	AJ-100CS
208/60/1	147.4	27.3
230/60/1	136.0	27.3
208/60/3	87.4	17.9
230/60/3	80.7	17.9
460/60/3	40.4	8.9

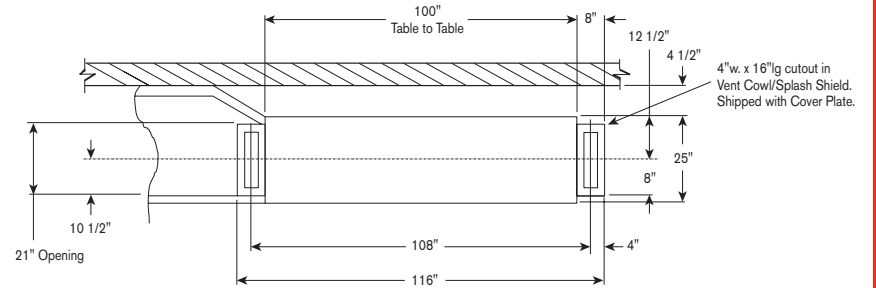

Recommended Table Fabrication

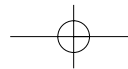
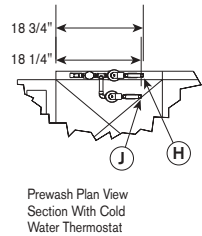
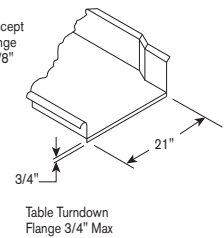
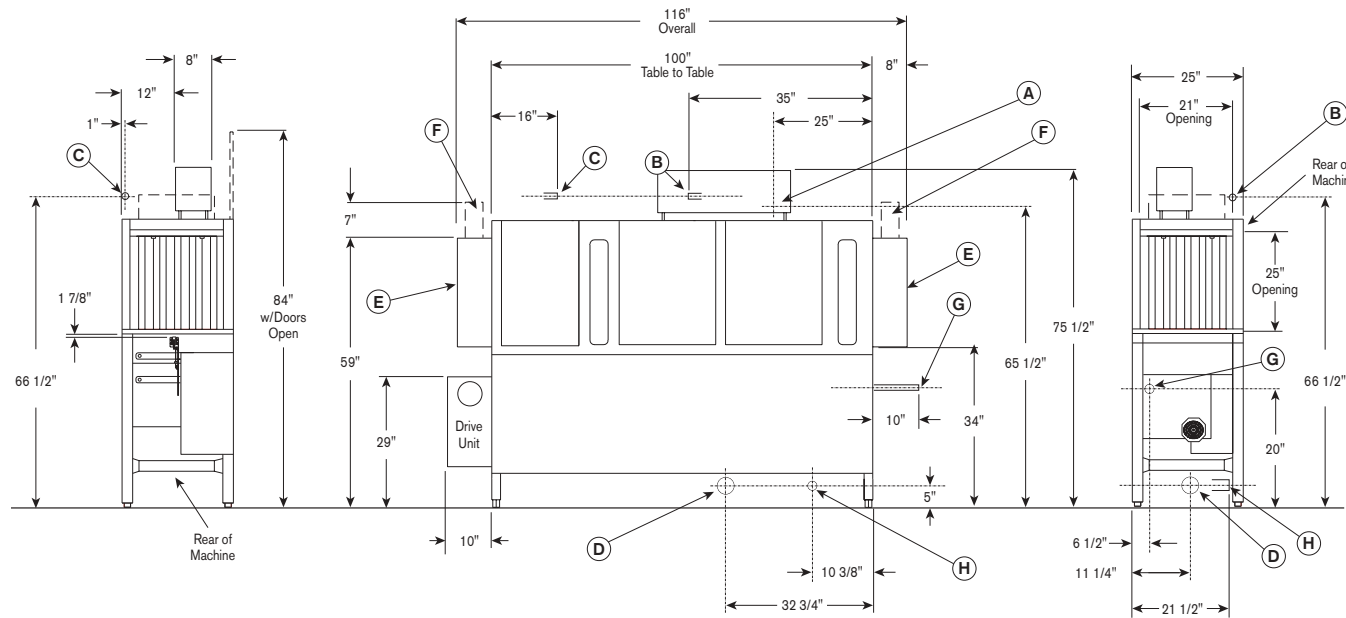
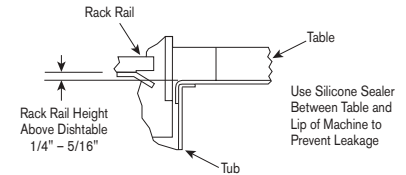

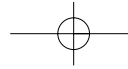

AJ-100 Vision Series



Right to Left Operation Shown

Legend to Drawing

- A** - Electrical Connection-See Table for Amperage Requirements
- B** - Water Inlet-3/4" I.P.S., 180°F Water Required
- C** - Water Inlet-3/4" I.P.S., 140°F Water Required
- D** - Drain Connection-1 1/2" I.P.S. Vent Collar/Splash Shield
- F** - Vent Collar with Damper 4"w. x 16"lg x 7"high-**Optional**
- G** - Steam Connection-1" I.P.S.
- H** - Condensate Return-1" I.P.S.

Approximate Total Load Amperes

Power Supply	AJ100CE	AJ-100CS
208/60/1	147.4	27.3
230/60/1	136.0	27.3
208/60/3	87.4	17.9
230/60/3	80.7	17.9
460/60/3	40.4	8.9

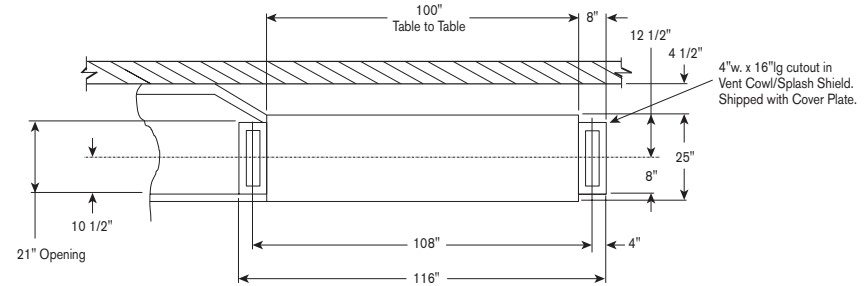

Recommended Table Fabrication

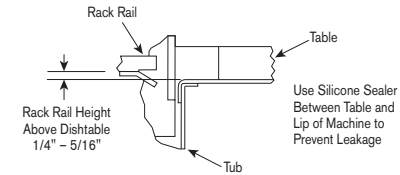

Note: Tub Will Accept a Table Flange Up to 24 7/8"

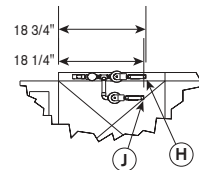
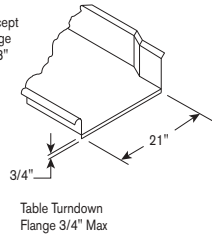

Prewash Plan View Section With Cold Water Thermostat

