



BEVERAGE-AIR

3779 Champion Blvd., Winston-Salem, NC 27105
1-888-845-9800 Fax# 1-336-245-6453
http://www.Beverage-Air.com

CUSTOMER'S CHOICE FOR A HOT LOCATION
Tested & Certified to Ambient Class of 100°F

3 Year Parts/Labor Warranty Additional 2 Year Compressor Warranty

LUMAVUE SERIES—PASS-THRU GLASS DOOR MERCHANDISER

Used for merchandising and storage of product.

CABINET CONSTRUCTION

Heavy duty construction includes white coated steel interior walls. Exterior finish is heavy-duty steel with a baked on durable coating. Choose from black or white finish.

Foamed-in-place CFC and HCFC-free polyurethane insulation enhances the structural strength of the cabinet and helps increase energy efficiency.

Modern, one-piece grille is easily removed for cleaning and servicing.

Double pane, lowE argon filled glass doors feature inside and outside panes that are tempered for added safety.

Two sliding glass doors (front and back) feature integral low profile door handles that are more aesthetically pleasing.

Hold-open feature is standard.

Pass-thru configuration.

Four white epoxy coated steel shelves are standard.

REFRIGERATION

Whisper-quiet refrigeration system uses R134a refrigerant, which is CFC and HCFC-free for compliance with environmental safety concerns.

Product temperatures from 32°F to 40°F.

ELECTRICAL

Interior fluorescent lighting enhances product illumination.

Units wired at factory and ready for connection to a 115/60/1 phase, 15 amp dedicated outlet. 8' long cord and plug set included.

Item No. _____
Quantity _____

**PASS-THRU SLIDING
GLASS DOOR LUMAVUE™
MERCHANDISER SERIES**
LV17-54

MODELS:
LV17-1-B-54
LV17-1-W-54



LV17-1-B-54

SPECIAL FEATURES

- Pass-Thru configuration
- Whisper-quiet refrigeration system
- Sliding glass doors
- 2010 Federal Energy Compliant
- Gravity Flo kits, Bev-Trac and Can Roller options available

ELECTRICAL CONNECTION



115/60/1
NEMA-5-15P

Units pre-wired at factory and include 8' long cord and plug set.



*Note: Not all markings may apply to all model variations.

Available From:

Model Specified _____	Store# _____
Location _____	Quantity _____



**LumaVue Pass-Thru Glass
Door Merchandisers
Model: LV17-54**

MODEL	LV17-54
EXTERNAL DIMENSIONAL DATA	
Length Overall (inches) Length Overall (mm)	36" 914
Depth Overall (inches) Depth Overall (mm)	24" 610
Height Overall— (inches) Height Overall— (mm)	60" 1524
Number of doors	2
INTERNAL DIMENSIONAL DATA	
NET Capacity (cubic ft.) NET Capacity (Liters)	17.5 481
Internal Length Overall (inches) Internal Length Overall (mm)	33" 838
Internal Depth Overall (inches) Internal Depth Overall (mm)	21" 533
Internal Height Overall—(inches) Internal Height Overall—(mm)	46 7/8" 1190
Number of shelves	4
ELECTRICAL DATA	
Full Load Amperes 115/60/1	6.2 A
REFRIGERATION DATA	
Horsepower	1/3
WEIGHT DATA	
Gross Weight (Crated lbs)	400
Gross Weight (Crated kg)	182

PLAN VIEWS

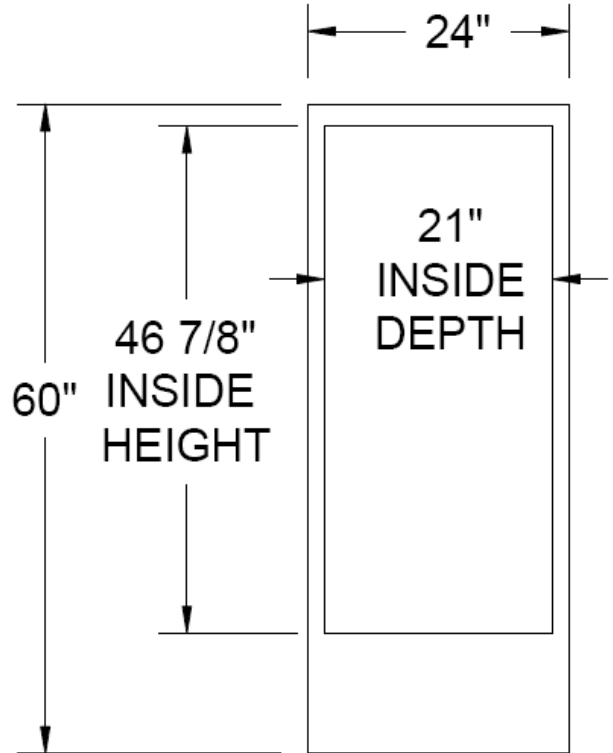

END

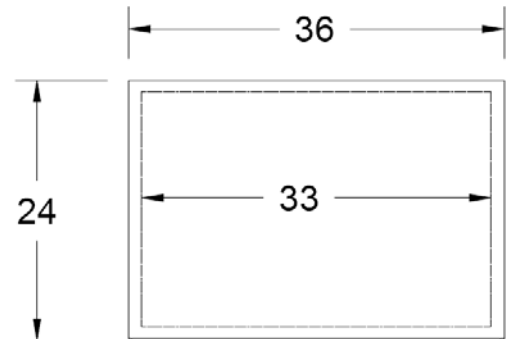

TOP



Note: Not all markings may apply to all model variations.

BEVERAGE-AIR® CORPORATION

3779 Champion Blvd. • Winston-Salem, NC 27105 USA • (336) 245-6400 • Fax (336) 245-6453 • (888) 845-9800 • www.beverage-air.com

Specifications are subject to change without prior notice. 06/13