

COMBITHERM®

7•14Esi

COMBIoven™

Boiler-FREE



MODEL 7•14Esi DELUXE

CAPACITY OF FOURTEEN (14) FULL-SIZE OR GN 1/1 PANS,
SEVEN (7) FULL-SIZE SHEET OR GN 2/1 PANS
SHOWN WITH OPTIONAL MOBILE STAND 5005737

- Flash-steam generation makes conventional steam generator obsolete:
 - Eliminates steam generating boiler maintenance
 - Ends boiler heating element burn-out
 - Maintains steam levels without a water reservoir
- Cook by internal product temperature or time with temperature variable steam, convection heat, or a combination of both to roast, steam, bake, or oven-fry in a single piece of equipment.
- Provides increased food quality and expands menu options while increasing production efficiency and speed by as much as 70-percent compared to conventional cooking methods.
- EcoSmart™ technology reduces energy cost by using less electricity and water during both normal operation and the cleaning function.
- Gold-n-Brown™ feature provides the operator with the ability to add additional product color.
- CombiClean™ feature uses scrubbing jets of water for fully automatic cleaning. Use either commercial-strength CombiClean Tablets or Combitherm Cleaning Liquid Spray.
- Standard and Deluxe control offers additional moisture injection, Delta-T cooking, multiple language display, and other features.
- Enhanced safety feature includes automatic steam venting immediately before cooking time expires. (U.S. Pat. 7,282,674)
- CombiSmoke™ is an optional feature — patented smoking technology (U.S. Pat. 7,157,668; EU Pat. 1659911) that gives operators the unique ability to smoke any product, hot or cold.

SHORT FORM SPECIFICATIONS:

Provide Alto-Shaam Combitherm® counter-top Model 7•14Esi flash-steam electric CombiOven designed with EcoSmart™ technology for reduced energy and water usage and include operational modes for steam, convection, and a combination of steam and convection heat. Standard features to include patented automatic steam venting; Gold-n-Brown™ browning function; and a self-adjusting, flush-mounted rotary door handle with a steam venting safety stop. Control to include 2-speed fan and cool-down function. Oven is to be constructed of 18 gauge stainless steel, include an attached spray hose with backflow preventer, and automatic cleaning function. The oven is to accommodate up to 7 full-size sheet pans or 14 full-size hotel pans, and standard right-hand door hinging. The oven is to include the patented CombiSmoke™ smoking function (*only if requested with order*).

STANDARD CONTROL: To include removable quick-connect internal product temperature probe in the oven interior.

DELUXE CONTROL: To include removable quick-connect internal product temperature probe in the oven interior and programming capability with Rapid-Touch™ operational quick-keys.

S-CONTROL: To include removable quick-connect internal product temperature probe in the oven interior as an option.

MODELS:

7•14Esi: STANDARD

7•14Esi: DELUXE

7•14Esi: S-CONTROL

STANDARD FEATURES AND ACCESSORIES

- Four (4) stainless steel shelves
- Two (2) stainless steel side racks with Seven (7) non-tilt pan support rails
21-1/16" (535mm) horizontal width between rails
2-5/8" (65mm) vertical spacing between rails
- Four (4) removable adjustable legs
- One (1) hand-held shower with backflow preventer PATENT PENDING
- One (1) flush-mounted rotary door latch with steam venting position
- Single-point detachable temperature probe (OPTIONAL ON S-CONTROL MODELS)



ALTO-SHAAM

W164 N9221 Water Street • P.O. Box 450 • Menomonee Falls, Wisconsin 53052-0450 • U.S.A.
PHONE: 262.251.3800 800.558.8744 U.S.A./CANADA FAX: 262.251.7067 800.329.8744 U.S.A. ONLY
www.alto-shaam.com



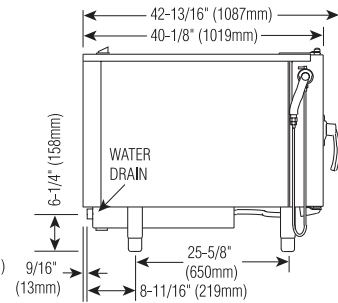
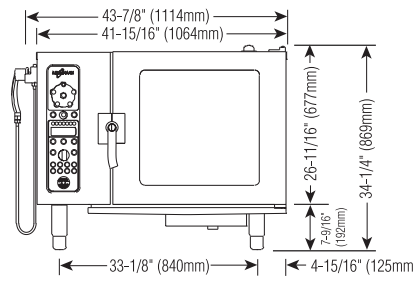
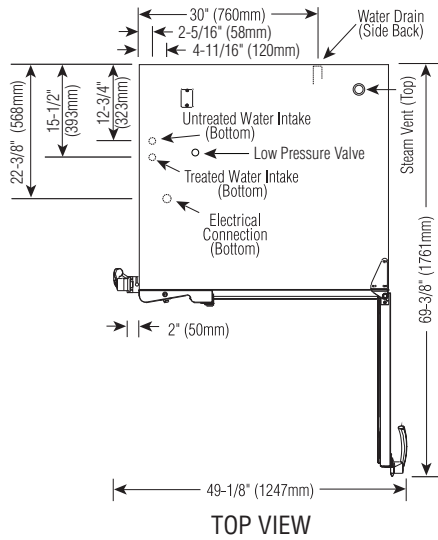

FRONT VIEW

SIDE VIEW

DIMENSIONS: H x W x D	
EXTERIOR:	34-1/4" x 43-7/8" x 42-13/16" (869mm x 1114mm x 1087mm)
EXTERIOR WITH RETRACTABLE DOOR:	34-1/4" x 47-7/8" x 42-13/16" (869mm x 1216mm x 1087mm)
INTERIOR:	20-5/16" x 23-1/2" x 28-7/8" (515mm x 596mm x 722mm)

INSTALLATION REQUIREMENTS
Oven must be installed level.
Hood installation is required.
Water supply shut-off valve and back-flow preventer.

WATER REQUIREMENTS
TWO (2) COLD WATER INLETS - DRINKING QUALITY
ONE (1) TREATED WATER INLET: 3/4" NPT*
ONE (1) UNTREATED WATER INLET: 3/4" NPT*
LINE PRESSURE: 30 to 90 psi 2.8 to 6.2 bar
WATER DRAIN: 1-1/2" CONNECTION WITH AIR GAP
* Can manifold off of one 3/4" line.

WATER QUALITY MINIMUM STANDARDS																
USING A WATER SUPPLY NOT MEETING ALTO-SHAAM'S MINIMUM WATER QUALITY STANDARDS WILL VOID THIS WARRANTY. It is the responsibility of the purchaser to ensure that incoming water supply is compliant with the specifications listed through adequate treatment measures. Installation of the CombiGuard™ Water Filtration System is recommended, but this system may not address all water quality issues present.																
<table border="0"> <tr> <td>Contaminant</td> <td>Inlet Water Requirements (untreated water)</td> </tr> <tr> <td>Free Chlorine</td> <td>Less than 0.1 ppm (mg/L)</td> </tr> <tr> <td>Hardness</td> <td>Less than 3 gpg (52 ppm)</td> </tr> <tr> <td>Chloride</td> <td>Less than 30 ppm (mg/L)</td> </tr> <tr> <td>pH</td> <td>7.0 to 8.5</td> </tr> <tr> <td>Alkalinity</td> <td>Less than 50 ppm (mg/L)</td> </tr> <tr> <td>Silica</td> <td>Less than 12 ppm (mg/L)</td> </tr> <tr> <td>Total Dissolved Solids (tds)</td> <td>Less than 60 ppm</td> </tr> </table>	Contaminant	Inlet Water Requirements (untreated water)	Free Chlorine	Less than 0.1 ppm (mg/L)	Hardness	Less than 3 gpg (52 ppm)	Chloride	Less than 30 ppm (mg/L)	pH	7.0 to 8.5	Alkalinity	Less than 50 ppm (mg/L)	Silica	Less than 12 ppm (mg/L)	Total Dissolved Solids (tds)	Less than 60 ppm
Contaminant	Inlet Water Requirements (untreated water)															
Free Chlorine	Less than 0.1 ppm (mg/L)															
Hardness	Less than 3 gpg (52 ppm)															
Chloride	Less than 30 ppm (mg/L)															
pH	7.0 to 8.5															
Alkalinity	Less than 50 ppm (mg/L)															
Silica	Less than 12 ppm (mg/L)															
Total Dissolved Solids (tds)	Less than 60 ppm															

CLEARANCE REQUIREMENTS
LEFT: 6" (152mm) PLUS SERVICE ACCESS: 18" (457mm) RECOMMENDED
20" (508mm) FROM HEAT PRODUCING EQUIPMENT
RIGHT: 4" (102mm) TOP: 20" (508mm) FOR AIR MOVEMENT
BACK: 4" (102mm) BOTTOM: 5-1/8" (130mm) FOR LEGS
COUNTER-TOP INSTALLATIONS MUST MAINTAIN 4" (102mm) MINIMUM CLEARANCE FROM COUNTER SURFACE.

ELECTRICAL (DEDICATED CIRCUIT REQUIRED)					7•14esi		7•14esi/sk	
	VOLTAGE	PHASE	CYCLE/HZ	AWG	AMPS	kW	AMPS	kW
208-240	at 208	1*	60	2 Wire plus ground	67.0	13.9	69.2	14.4
	at 240			AWG 3	77.0	18.4	79.0	18.9
208-240	at 208	3	60	3 Wire plus ground	38.6/ph	13.9	40.0/ph	14.4
	at 240			AWG 6	44.3/ph	18.4	45.5/ph	18.9
380-415	at 380	3	50	4 Wire plus ground	21.1/ph	13.9	22.0/ph	14.4
	at 415			AWG 10	25.6/ph	18.4	26.3/ph	18.9
440-480	at 440	3*	60	3 Wire plus ground	20.0/ph	15.4	21.0/ph	15.9
	at 480			AWG 8	22.0/ph	18.4	23.0/ph	18.9

* ELECTRICAL SERVICE CHARGE APPLIES

WEIGHT			CAPACITY				
NET	405 lb	(184 kg)	FULL-SIZE PANS: 20" x 12" x 2-1/2"		Fourteen (14)	Twelve (12)	
SHIP	540 lb	(245 kg)	GN 1/1: 530 x 325 x 65mm		Fourteen (14)	Twelve (12)	
CRATE DIMENSIONS: (L x W x H) 53" x 45" x 49" (1346 x 1143 x 1245mm)			GN 2/1: 650 x 530 x 65mm		Seven (7)	Five (5)	
			FULL-SIZE SHEET PANS:* 18" x 26" x 1" ON WIRE SHELVES ONLY		Seven (7)	Six (6)	
			168 lb (76 kg) MAXIMUM				
			VOLUME MAXIMUM: 105 QUARTS (133 LITERS)				

* ADDITIONAL WIRE SHELVES REQUIRED FOR MAXIMUM CAPACITY

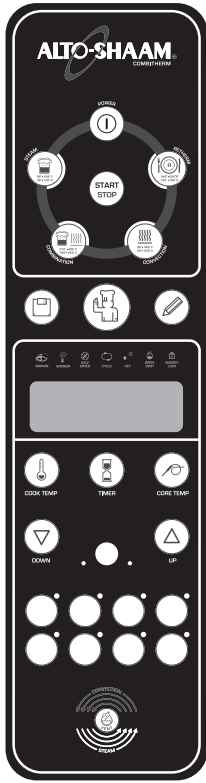

Deluxe Control

(PICTURED)

The CombiTherm deluxe control includes all the operational functions of the standard control and adds a programming function. Program memory can accept up to 250 procedures, each with up to 20 steps in any combination of cooking modes. The deluxe control also features a set of 8 Rapid-Touch™ keys to assign frequently used programs to cook at the touch of a single button.

Standard Control

The CombiTherm standard control includes all operational functions shown to steam, bake, and roast by time or internal product temperature. The control features the Gold-n-Brown™ automatic browning function, a Retherm Mode for plate regeneration, plus a wide variety of auxiliary functions and operational settings. This control is offered for operators that do not require programming capability.



S-Control

The CombiTherm S-Control includes all basic combination oven operational modes with the use of rotary dials. The S-Control also features the Gold-n-Brown™ automatic browning function, an automatic cleaning setting, an oven cool-down function, and a half-speed fan position. S-Control models can also be furnished with CombiSmoke or Core Temperature option package.



Steam Mode

Automatic steaming at 212°F (100°C)
Quick steaming between 213°F and 248°F (101°C and 120°C)
Low temp steaming between 86°F and 211°F (30°C and 99°C)



Combination Mode

Steam and convection cooking with a temperature range of 212°F to 482°F (100°C to 250°C)

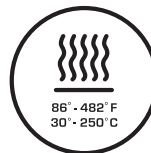

Convection Mode

Cooking without steam at a temperature range of 86°F to 482°F (30°C to 250°C)

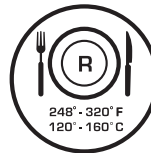

Retherm Mode

Food or plated meal reheating with automatic steam injection at a temperature range of 248°F to 320°F (120°C to 160°C)

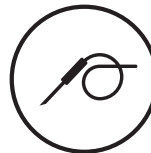

Core Temperature Mode

Cooking by sensing internal product temperature in any selected cooking mode



Gold-n-Brown™

An automatic browning function to be set or programmed as needed to add additional product color in the combination or convection mode of operation.



CombiSmoke™ (option)

Patented Alto-Shaam technology (U.S. Pat. 7,157,668; EU Pat. 1659911) provides the ability to smoke any product, hot or cold, utilizing real wood chips. The smoking feature functions in both combination and convection mode and can be programmed into deluxe model operating procedure.

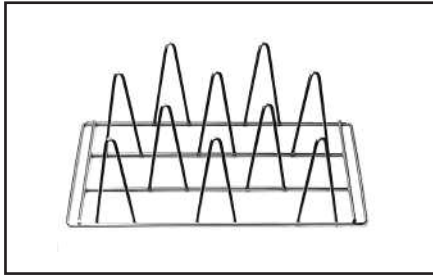

Ten (10) Chicken Roasting Rack
SH-22634



Six (6) Chicken Roasting Rack
(PAN NOT INCLUDED) SH-23000



Fry Basket BS-26730

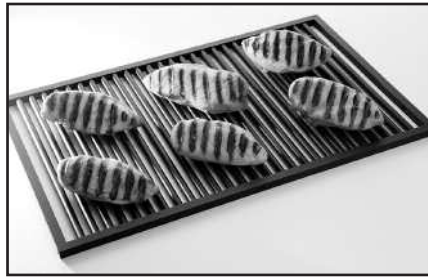

Grilling Grate SH-26731

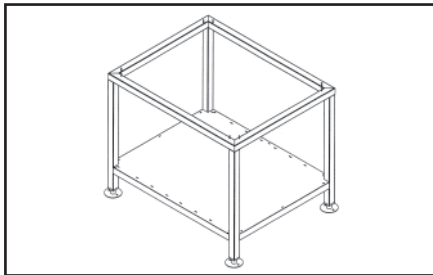

Stationary Stand with Shelf
5005731

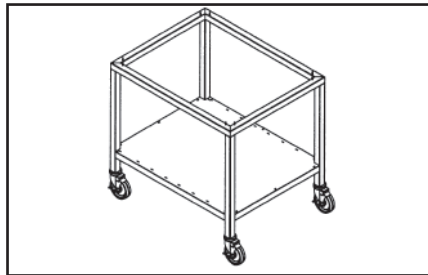

Mobile Stand with Shelf
5005735

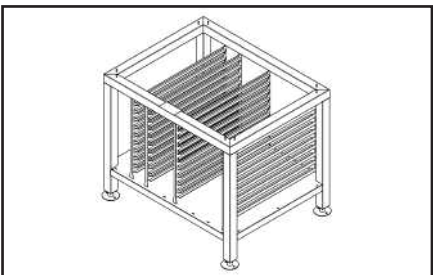

Stationary Stand with Pan Slides & Shelf
5005732

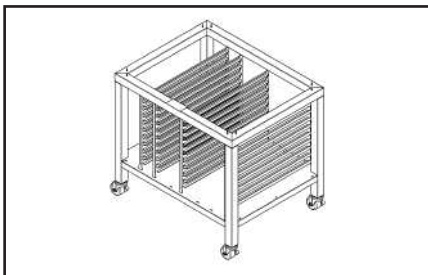

Mobile Stand with Pan Slides & Shelf
5005736

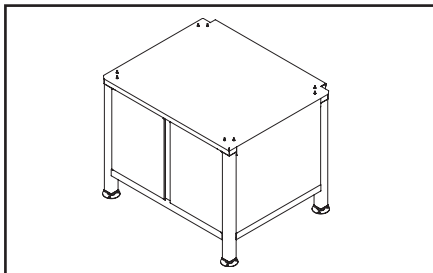

Stationary Stand with Shelf & Skirt
5005733

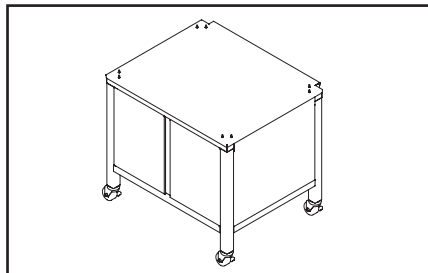

Mobile Stand with Shelf & Skirt
5005737



FACTORY INSTALLED OPTIONS

(MAY REQUIRE ADDITIONAL LEAD TIME)

- CombiSmoke™** (U.S. Pat. 7,157,668; EU Pat. 1659911)
 NO CHARGE WHEN REQUESTED AT TIME OF ORDER.
 SAMPLE BAG OF WOOD CHIPS INCLUDED.



- Recessed Door**
 INCREASES OVEN WIDTH BY 4" (102mm)

- Left-Hand Door Swing**
 INCREASES OVEN WIDTH BY 1" (25mm)

Single-point removable temperature probe

INCLUDED ON STANDARD AND DELUXE OVENS

- OPTIONAL ON S-CONTROL OVENS WITHOUT COMBISMOKE OPTION [5005679]
- OPTIONAL ON S-CONTROL OVENS WITH COMBISMOKE OPTION [5011457]
- Multi-point, hard-wired internal product temperature probe** [5005678]
 NOT AVAILABLE ON OVENS WITH S-CONTROL

- Grease Collection System** [5008038]
 MOBILE COLLECTION TANK ON CASTERS WITH DEDICATED OVEN GREASE DRAIN LINE
 OPTIONAL OVEN STAND IS REQUIRED FOR USE WITH THIS SYSTEM

- Security Devices** FOR CORRECTIONAL FACILITY USE
 EXCLUDES TEMPERATURE PROBE

Additional Security Options

- ANTI ENTRAPMENT DEVICE [5011081]
- CONTROL PANEL SECURITY COVER [5011080]
- HASP DOOR LOCK (PADLOCKS NOT INCLUDED) [5011079]
- SEISMIC LEG PACKAGE (FOR BOLTING TO THE COUNTERTOP) [5011135]
- TAMPER-PROOF SCREW PACKAGE FOR OVEN [5011082]

- Ventless Hood VHes-10** [5011181]
 NOT AVAILABLE ON SMOKER MODELS OR STACKED COMBINATIONS

- Stacking Combinations**
 MUST BE SPECIFIED AT TIME OF ORDER
 SEE INDIVIDUAL STACKING COMBINATION SPECIFICATIONS SHEETS

- 6•10ES OVER 7•14ESi, STATIONARY
- 6•10ESi OVER 7•14ESi, STATIONARY
- 6•10ESiN OVER 7•14ESi, STATIONARY
- 7•14ES OVER 7•14ESi, STATIONARY
- 7•14ESi OVER 7•14ESi, STATIONARY
- ADDITIONAL MOBILE STACKING BASE
- 7•14ESi OVER ASC-4E CONVECTION OVEN, STATIONARY

- Computer Software Options** [5005676]
Not available on S-Control Models.
 REFER TO HACCP SPECIFICATION SHEET #9015
 FOR APPLICABLE PART NUMBERS

- HACCP Documentation**
- HACCP Documentation with Kitchen Management**



- Wireless HACCP Documentation with Kitchen Management**
- IEEE 802.11b STANDARDS**





OPTIONS & ACCESSORIES		
<input type="checkbox"/>	CHICKEN GREASE TRAY WITH DRAIN: 1-1/2" (38mm) DEEP	4758
<input type="checkbox"/>	CHICKEN GREASE TRAY WITH DRAIN: 2-3/4" (70mm) DEEP	14475
CHICKEN ROASTING RACKS:		
<input type="checkbox"/>	6 CHICKEN CAPACITY — FITS FULL-SIZE PAN: 4 RACKS PER OVEN	SH-23000
<input type="checkbox"/>	8 CHICKEN CAPACITY — FITS FULL-SIZE PAN: 4 RACKS PER OVEN	SH-23619
<input type="checkbox"/>	10 CHICKEN CAPACITY — FITS IN SIDE RACKS: 4 RACKS PER OVEN	SH-22634
<input type="checkbox"/>	COMBIGUARD™ TRIPLE-GUARD WATER FILTRATION SYSTEM (INCLUDES 1 CARTRIDGE)	FI-23014
<input type="checkbox"/>	COMBIGUARD™ REPLACEMENT FILTER	FI-26356
<input type="checkbox"/>	COMBITHERM CLEANING LIQUID — SPECIALLY FORMULATED FOR COMBITHERM OVENS	
	➔ TWELVE (12) CONTAINERS/CASE, 1 QUART (C. 1 LITER) EACH	CE-24750
<input type="checkbox"/>	COMBICLEAN™ TABLETS — SPECIALLY FORMULATED FOR COMBITHERM OVENS	
	➔ 90 PACKETS EACH CONTAINER - MUST BE ORDERED IN EVEN QUANTITIES OF TWO (2) OR MORE	CE-28892
<input type="checkbox"/>	FRY BASKET , 12" x 20" (325mm x 530mm)	BS-26730
<input type="checkbox"/>	GRILLING GRATE , 12" x 20" (325mm x 530mm)	SH-26731
<input type="checkbox"/>	SCALE FREE™ (CITRUS BASED, NON-CORROSIVE DELIMING PRODUCT)	CE-27889
<input type="checkbox"/>	SERVICE START-UP CHECK AVAILABLE THROUGH AN ALTO-SHAAM FASTEAM CENTER	SPECIFY AS REQUIRED
<input type="checkbox"/>	SHELF, STAINLESS STEEL WIRE	SH-22584
STAND, STAINLESS STEEL (H X W X D):		
<input type="checkbox"/>	➔ STATIONARY WITH SHELF	29-7/16" x 35-7/16" x 28" (746mm x 900mm x 710mm) 5005731
<input type="checkbox"/>	➔ STATIONARY WITH PAN SLIDES & SHELF	29-7/16" x 35-7/16" x 28" (746mm x 900mm x 710mm) 5005732
<input type="checkbox"/>	➔ STATIONARY WITH SHELF & SKIRT	29-7/16" x 35-7/16" x 29-5/8" (746mm x 900mm x 751mm) 5005733
<input type="checkbox"/>	➔ STATIONARY WITH PAN SLIDES, SHELF, & SKIRT	29-7/16" x 35-7/16" x 29-5/8" (746mm x 900mm x 751mm) 5005734
<input type="checkbox"/>	➔ MOBILE WITH SHELF	32-1/16" x 35-7/16" x 28" (815mm x 900mm x 710mm) 5005735
<input type="checkbox"/>	➔ MOBILE WITH PAN SLIDES & SHELF	32-1/16" x 35-7/16" x 28" (815mm x 900mm x 710mm) 5005736
<input type="checkbox"/>	➔ MOBILE WITH SHELF & SKIRT	32-1/16" x 35-7/16" x 29-5/8" (815mm x 900mm x 751mm) 5005737
<input type="checkbox"/>	➔ MOBILE WITH PAN SLIDES, SHELF, & SKIRT	32-1/16" x 35-7/16" x 29-5/8" (815mm x 900mm x 751mm) 5005738
<input type="checkbox"/>	➔ STATIONARY	37-3/4" x 35-7/16" x 28" (957mm x 900mm x 710mm) 5006170
WOOD CHIPS — BULK PACK 20 lb (9 kg)		
<input type="checkbox"/>	➔ Apple . . .WC-22543	<input type="checkbox"/>
<input type="checkbox"/>	➔ Cherry . . .WC-22541	<input type="checkbox"/>
<input type="checkbox"/>	➔ Hickory . . .WC-2829	<input type="checkbox"/>
<input type="checkbox"/>	➔ Maple . . .WC-22545	