



Heavy-Duty Commercial, Combination & Bagel Toasters

Features

- Uniformly toasts regular bread, Texas toast, frozen waffles, and many other foods
- Easily replaceable industrial heating plates
- Standard 4-slice, combination bread and bagel and dedicated bagel toasters available
- WCT850 (not pictured) Standard/Bagel Switchable Toaster
- Bagel slots toast on cut side only
- Electronic browning controls and carriage control levers
- Dishwasher-safe crumb tray
- Limited One Year Warranty



WCT810/WCT815/WCT815B
Combination Toasters



WCT820/WCT825/WCT825B
Bagel Toasters



WCT800RC/WCT800
WCT805/WCT805B
Standard 4-Slice Toasters



Heavy-Duty Commercial, Combination & Bagel Toasters

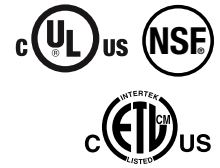

Item	Electrical	Listings	Watts	Amps	Plug	Output (Slices/Hour)	Slot Width
WCT800RC	120 VAC, 50/60 Hz	UL, CUL, NSF	1800	15	NEMA 5-15P	240	(4) 1 1/8"
WCT800	120 VAC, 50/60 Hz	ETL, NSF	2200	19	NEMA 5-20P	300	(4) 1 1/8"
WCT805B	208 VAC, 50/60 Hz	UL, CUL, NSF	2700	13	NEMA 6-20P	380	(4) 1 1/8"
WCT805	240 VAC, 50/60 Hz	UL, CUL, NSF	2700	12	NEMA 6-15P	380	(4) 1 1/8"
WCT810	120 VAC, 50/60 Hz	ETL, NSF	2025	17	NEMA 5-20P	380	(2) 1 1/8", (2) 1 1/2"
WCT815B	208 VAC, 50/60 Hz	UL, CUL, NSF	2025	10	NEMA 6-15P	380	(2) 1 1/8", (2) 1 1/2"
WCT815	240 VAC, 50/60 Hz	UL, CUL, NSF	2025	9	NEMA 6-15P	380	(2) 1 1/8", (2) 1 1/2"
WCT820	120 VAC, 50/60 Hz	ETL, NSF	1500	12.5	NEMA 5-15P	380	(4) 1 1/2"
WCT825	240 VAC, 50/60 Hz	ETL, NSF	1500	6.25	NEMA 6-15P	380	(4) 1 1/2"
WCT825B	208 VAC, 50/60 Hz	ETL, NSF	1500	7.25	NEMA 6-15P	380	(4) 1 1/2"
WCT850	208 VAC, 50/60 Hz	ETL, NSF	2800+	13.8+	NEMA 6-20P	360+	(4) 1 1/2"

Ordering Information

All models listed have a Limited 1 Year Warranty.

+ Maximum when both sides switched to TOAST

Description	Catalog #	Std Pkg.	Ship Wt. (lbs.)	Cubic Feet	UPC Code
Heavy-Duty 120V Standard Toaster	WCT800RC	1	22	1.6	040072002915
Heavy-Duty 120V Standard Toaster	WCT800	1	22	1.6	040072001451
Heavy-Duty 208V Standard Toaster	WCT805B	1	22	1.6	040072003196
Heavy-Duty 240V Standard Toaster	WCT805	1	22	1.6	040072001468
Heavy-Duty 120V Combination Toaster	WCT810	1	22	1.6	040072001475
Heavy-Duty 208V Combination Toaster	WCT815B	1	22	1.6	040072003219
Heavy-Duty 240V Combination Toaster	WCT815	1	22	1.6	040072001482
Heavy-Duty 120V Bagel Toaster	WCT820	1	22	1.6	040072010019
Heavy-Duty 240V Bagel Toaster	WCT825	1	22	1.6	040072010972
Heavy-Duty 208V Bagel Toaster	WCT825B	1	22	1.6	040072010989
Heavy-Duty 208V Switchable Toaster	WCT850	1	22	1.6	040072014314

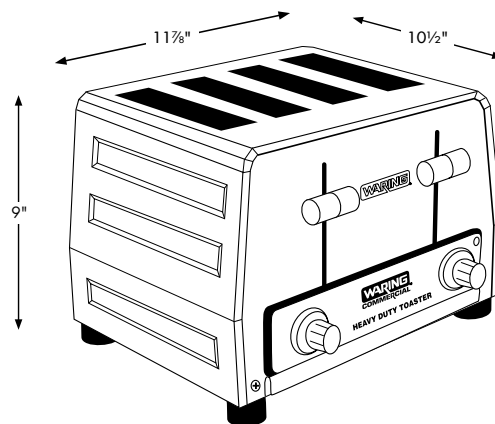

Dimensions are the same for all models.
(9" H x 11 1/8" W x 10 1/2" D)