



Project	Quantity	Item #
Model Specified:		CSI Section 11400

"N-Width" Reach-In Refrigerator & Freezer Models/Self-Contained



INTELA-TRAUL® Equipped!



Model RHT132NUT-FHS
(shown with optional casters)

One Section Models, 32" Deep

R SERIES	Full Length Door Refrigerator Model	RHT132NUT-FHS
	Half Length Door Refrigerator Model	RHT132NUT-HHS
	Full Length Door Freezer Model	RLT132NUT-FHS
	Half Length Door Freezer Model	RLT132NUT-HHS

A SERIES	Full Length Door Refrigerator Model	AHT132NUT-FHS
	Half Length Door Refrigerator Model	AHT132NUT-HHS
	Full Length Door Freezer Model	ALT132NUT-FHS
	Half Length Door Freezer Model	ALT132NUT-HHS

The R & A Series represent Traulsen's Top-of-the-Line product offering. The one section "N-Width" reach-in refrigerator and freezer models are both designed to offer maximum interior storage capacity, along with wide doors for use of 18" x 26" pans, all within a less than 27" left to right footprint. Each is supplied standard with such high quality features as balanced refrigeration systems, microprocessor controls, communications ability and stainless steel exteriors. Additionally, they offer the widest range of optional accessories to choose from, and can be specified for use with many different applications, including: Foodservice, Correctional, Institutional, Export, etc.

Standard Product Features

- R-Series: Stainless Steel Exterior & Interior
- A-Series: Stainless Steel Exterior/Anodized Aluminum Interior
- INTELA-TRAUL® Microprocessor Control System
- Balanced, Self-Contained Refrigeration Systems
- Full or Half Length Stainless Steel Doors With Locks
- Self-Closing Doors With Stay Open Feature At 120 Degrees
- Guaranteed For Life Cam-Lift Hinges & Door Handles
- Standard Door Hinging: 132N = Right (other hinging available)
- Automatically Activated Incandescent Lights
- Three Adjustable Wire Shelves Per Section
- Automatic Condensate Evaporator
- Magnetic Snap-In Door Gaskets
- Gasket Protecting Metal Door Liner
- Controllable Anti-Condensate Door Perimeter Heaters
- Thermostatic Expansion Valve Metering Device
- Stainless Steel Breaker Caps & One-Piece Louver Assembly
- 9' Cord & Plug Attached
- Set of Four (4) 6" High Adjustable Stainless Steel Legs
- One Year Parts And Labor Warranty
- Two Year Control Warranty (parts and labor)
- Five Year Compressor Warranty

Options & Accessories

- Stainless Steel Finished Back With Rear Louvers
- Re-Hinging Feature For Doors
- No. 1 Type Tray Slides To Accommodate either (1) 18" x 26" or (2) 14" x 18" Sheet Pans, Adjustable To 2" O.C.
- No. 2 Type Tray Slides To Accommodate (1) 18" x 26" Sheet Pans, Adjustable To 2" O.C.
- Additional Wire Shelves
- Stainless Steel Shelves
- Kool Klad Exterior Laminate Decor
- Set of Four (4) 6" High Casters In Lieu of Legs
- Set of Four (4) 4-5/8" High Casters In Lieu of Legs
- 4-1/2" High Stainless Steel Base In Lieu of Legs
- 6" High Stainless Steel Kickplate (for use with standard legs)
- Remote Applications (see form TR35837 for more details)
- Remote For Use With 20°F Glycol System (refrigerator models only)
- Water Cooled Self-Contained Condenser Suitable for Connection To Glycol (freezer models only)
- Two Year Service/Labor Warranty Available



Listed by Underwriters Laboratories Inc., and classified by Underwriters Laboratories Inc., in accordance with ANSI/NSF7.

AW-03118

Approval: _____



TRAULSEN
 4401 BLUE MOUND RD.
 PHONE 1 (800) 825-8220
 Website: www.traulsen.com

FT. WORTH, TX 76106
 FAX-MKTG. 1 (817) 624-4302

Project	Quantity	Item #
Model Specified:		CSI Section 11400

Specifications

Construction, Hardware and Insulation

Cabinet exterior front, one piece sides, louver assembly and doors are constructed of 20 gauge stainless steel with #4 finish. Cabinet interior and door liners are constructed of stainless steel (anodized aluminum in the A-Series). The exterior cabinet top, back and bottom are constructed of heavy gauge aluminized steel. A set of four (4) adjustable 6" high stainless steel legs are included.

Doors are equipped with a gasket protecting metal door pan, removable plug cylinder locks and guaranteed for life cam-lift, gravity action, self-closing metal, glide hinges with stay open feature at 120 degrees. Hinges include a concealed switch to automatically activate the interior incandescent lighting. Guaranteed for life, work flow door handles are mounted horizontally over recess in door which limits protrusion from door face into aisles. Doors have seamless, polished metal corners.

Easily removable for cleaning, vinyl magnetic door gasket assures tight door seal. Anti condensate heaters are located behind each door opening.

Both the cabinet and door(s) are insulated with an average of 2" thick high density, non-CFC, foamed in place polyurethane.

DIMENSIONAL DATA	R/AHT132NUT	R/ALT132NUT
Equipment Type	Refrigerator	Freezer
Net capacity cu. ft.	21.9 (593 cu l)	21.9 (593 cu l)
Length - overall in.	26 ³ / ₈ (67.0 cm)	26 ³ / ₈ (67.0 cm)
Depth - overall in.	35 (88.8 cm)	35 (88.8 cm)
Depth - less handle in.	33 ³ / ₄ (84.4 cm)	33 ³ / ₄ (84.4 cm)
Depth - over body in.	32 (81.3 cm)	32 (81.3 cm)
Depth - door open 90° in.	57 ⁵ / ₈ (146.3 cm)	57 ⁵ / ₈ (146.3 cm)
Clear door width in.	21 ¹ / ₈ (53.6 cm)	21 ¹ / ₈ (53.6 cm)
Clear half-door height in.	27 ¹ / ₂ (69.9 cm)	27 ¹ / ₂ (69.9 cm)
Clear full-door height in.	57 ⁵ / ₈ (146.3 cm)	57 ⁵ / ₈ (146.3 cm)
Height - overall on 6" legs	83 ¹ / ₄ (211.5 cm)	83 ¹ / ₄ (211.5 cm)
R-Series Net Wt. lbs.	330 (149 kg)	365 (164 kg)
A-Series Net Wt. lbs.	280 (126 kg)	315 (142 kg)
No. Standard Shelves	3	3
Shelf area sq. ft. ¹	12.5 (1.16 sq m)	12.5 (1.16 sq m)
ELECTRICAL DATA		
Voltage	115/60/1	115/60/1
Feed wires with Ground	3	3
Full load amperes	6.0	9.8
REFRIGERATION DATA		
Refrigerant	R-134a	R-404A
BTU/HR H.P.	1730 (¼ HP) ²	2230 (½ HP) ³

NOTES

- NOTE: Figures in parentheses reflect metric equivalents.
- Area of standard shelf compliment only, does not include storage area of additional shelves or available on cabinet bottom.
 - Based on a 90 degree F ambient and 20 degree F evaporator.
 - Based on a 90 degree F ambient and -10 degree F evaporator.
 - For approximate remote weights deduct 40 lbs. from respective net or gross weight. For other information on remote models, please refer to form TR35837.



Refrigerator Models Equipped With One NEMA 5-15P Plug



Freezer Models Equipped With One NEMA 5-20P Plug

NOTE: Full load amps and plug style may vary depending on electrical options chosen and condensing unit employed.

NOTE: When ordering please specify: Voltage, Hinging, Door Size, Options and any additional warranties.

Continued product development may necessitate specification changes without notice. Part No. TR35773 (revised 1/10)

Refrigeration System - Refrigerator Models

A top mounted, self-contained, balanced refrigeration system using R-134a refrigerant is conveniently located behind the one piece louver assembly. It features an easy to clean front facing condenser, thermostatic expansion valve, air-cooled hermetic compressor, plenum effect blower coil, large, high humidity evaporator coil located outside the food zone and a top mounted non-electric condensate evaporator. Return air duct protects against introduction of warm kitchen air, promoting even temperature maintenance and efficient operation. A 9' cord and plug is provided. Standard operating temperature is 34 to 38°F.

Refrigeration System - Freezer Models

A top mounted, self-contained, balanced refrigeration system using R-404A refrigerant is conveniently located behind the one piece louver assembly. It features an easy to clean front facing condenser, thermostatic expansion valve, air-cooled hermetic compressor, interior mounted evaporator coil and a bottom-mounted electric condensate evaporator. A 9' cord and plug is provided. Standard operating temperature is 0 to -5°F.

Controller

The easy to use water resistant INTELA-TRAUL® microprocessor control system is supplied standard. Unit is NAFEM Data Protocol communication (NDP) ready. Optional hardware required to be NDP compliant. Third party software required for network connection. It includes a 3-Digit LED Display, Fahrenheit or Celsius Temperature Scale Display Capability, Defrost Lockouts (freezer models only) and an RS485 data port. In addition it includes audio/visual alarms for: Hi/Lo Cabinet Temperature, Door Open, Clean Condenser, Evaporator Coil and Discharge Line Sensor Failures, and Power Supply Interruption.

Interior

Standard interior arrangements include three (3) wire shelves per section. Recommended load limit per shelf should not exceed 225 lbs. Optional tray slides may be purchased in combination with, or in lieu of these. Both standard and optional interior arrangements are completely installed at the factory.

Warranties

Both a one year parts and labor warranty and a five year compressor warranty (self-contained models only) are provided standard. An optional 2nd year extended parts and labor warranty is also available. In addition the INTELA-TRAUL® control is warranted by a two year parts and labor warranty.

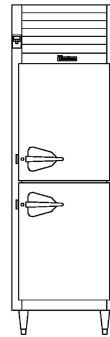

Elevation - All Models

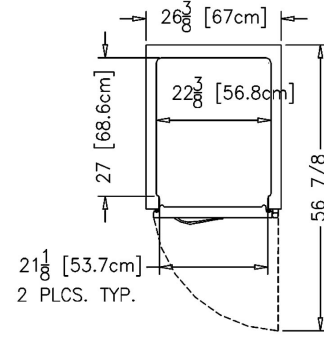

Plan - All Models

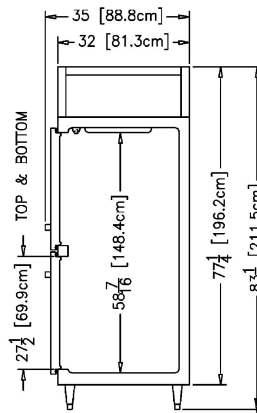

Section - HT132NUT

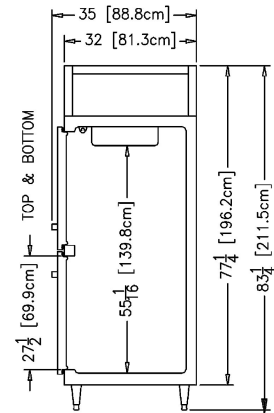

Section - LT132NUT

TRAULSEN
4401 BLUE MOUND RD.
PHONE 1 (800) 825-8220
Website: www.traulsen.com

FT. WORTH, TX 76106
FAX-MKTG. 1 (817) 624-4302



Remote Refrigeration Data

Refer to the below chart to determine the following remote characteristics: Voltage, Amps, BTU's, Refrigerant, and if the following components are included: Condensate Evaporator, Solenoid, Expansion Valve and Temperature Control.

Model No.	Voltage	Amps	BTU @ 90°F Ambient and Evap. Temp.	Cond. Evap.		Solenoid	Exp. Valve	Temp Control
				Refrig't	Yes/No	Yes/No	Yes/No	
G10000, etc.	115/60/1	4.1	1520 @ +20°F Evap	R-134a	Yes	Yes	Yes	Microprocessor
G10002P, etc.	115/60/1	4.1	1520 @ +20°F Evap	R-134a	Yes	Yes	Yes	Microprocessor
G11000, etc.	115/60/1	4.1	2410 @ +20°F Evap	R-134a	Yes	Yes	Yes	Microprocessor
G11002P, etc.	115/60/1	4.1	2400 @ +20°F Evap	R-134a	Yes	Yes	Yes	Microprocessor
G12010, etc.	115/60/1	10.6	1930 @ -10°F Evap	R-404A	Yes	Yes	Yes	Microprocessor
G20000, etc.	115/60/1	5.2	2410 @ +20°F Evap	R-134a	Yes	Yes	Yes	Microprocessor
G20004P, etc.	115/60/1	5.2	2410 @ +20°F Evap	R-134a	Yes	Yes	Yes	Microprocessor
G21000, etc.	115/60/1	5.2	4160 @ +20°F Evap	R-134a	Yes	Yes	Yes	Microprocessor
G21004P, etc.	115/60/1	5.2	4160 @ +20°F Evap	R-134a	Yes	Yes	Yes	Microprocessor
G22010, etc.	115/60/1	13.2	3080 @ -10°F Evap	R-404A	Yes	Yes	Yes	Microprocessor
G30000, etc.	115/60/1	5.2	3780 @ +20°F Evap	R-134a	Yes	Yes	Yes	Microprocessor
G31010, etc.	115/60/1	13.2	4710 @ -10°F Evap	R-404A	Yes	Yes	Yes	Microprocessor
G31310, etc.	115/60/1	13.2	4710 @ -10°F Evap	R-404A	Yes	Yes	Yes	Microprocessor
G32000, etc.	115/60/1	5.2	5330 @ +20°F Evap	R-134a	Yes	Yes	Yes	Microprocessor
R/AHT132W	115/60/1	1.5	2400 @ +20°F Evap	R-134a	No	Yes	Yes	Intela-Traul
R/AHT132EW	115/60/1	1.5	2400 @ +20°F Evap	R-134a	No	Yes	Yes	Intela-Traul
R/AHT232W	115/60/1	2.0	4360 @ +20°F Evap	R-134a	No	Yes	Yes	Intela-Traul
R/AHT332W	115/60/1	2.5	4360 @ +20°F Evap	R-134a	No	Yes	Yes	Intela-Traul
R/AHT232N	115/60/1	2.0	4360 @ +20°F Evap	R-134a	No	Yes	Yes	Intela-Traul
R/AHT332N	115/60/1	2.5	4360 @ +20°F Evap	R-134a	No	Yes	Yes	Intela-Traul
R/AHT126W	115/60/1	1.5	2400 @ +20°F Evap	R-134a	No	Yes	Yes	Intela-Traul
R/AHT226W	115/60/1	2.0	2400 @ +20°F Evap	R-134a	No	Yes	Yes	Intela-Traul
R/AHT132D	115/60/1	1.5	2400 @ +20°F Evap	R-134a	No	Yes	Yes	Intela-Traul
R/AHT232D	115/60/1	2.0	4360 @ +20°F Evap	R-134a	No	Yes	Yes	Intela-Traul
R/AHT132WP	115/60/1	2.0	2400 @ +20°F Evap	R-134a	No	Yes	Yes	Intela-Traul
R/AHT232WP	115/60/1	2.5	4360 @ +20°F Evap	R-134a	No	Yes	Yes	Intela-Traul
R/AHT332WP	115/60/1	3.0	4360 @ +20°F Evap	R-134a	No	Yes	Yes	Intela-Traul
R/AHT232NP	115/60/1	2.5	4360 @ +20°F Evap	R-134a	No	Yes	Yes	Intela-Traul
R/AHT332NP	115/60/1	3.0	4360 @ +20°F Evap	R-134a	No	Yes	Yes	Intela-Traul
R/AHT126WP	115/60/1	2.0	2400 @ +20°F Evap	R-134a	No	Yes	Yes	Intela-Traul
R/AHT226WP	115/60/1	2.5	2400 @ +20°F Evap	R-134a	No	Yes	Yes	Intela-Traul
R/ALT132W	115/60/1	7.5	2160 @ -20°F Evap	R-404A	No	Yes	Yes	Intela-Traul
R/ALT232W	115/60/1	10.0	3790 @ -20°F Evap	R-404A	No	Yes	Yes	Intela-Traul
R/ALT332W	115/60/1	11.0	5220 @ -20°F Evap	R-404A	No	Yes	Yes	Intela-Traul
R/ALT232N	115/60/1	10.0	3790 @ -20°F Evap	R-404A	No	Yes	Yes	Intela-Traul
R/ALT332N	115/60/1	11.0	5220 @ -20°F Evap	R-404A	No	Yes	Yes	Intela-Traul
R/ALT126W	115/60/1	4.0	1980 @ -20°F Evap	R-404A	No	Yes	Yes	Intela-Traul
R/ALT226W	115/60/1	7.5	3790 @ -20°F Evap	R-404A	No	Yes	Yes	Intela-Traul
R/ALT132D	115/60/1	6.0	2160 @ -20°F Evap	R-404A	No	Yes	Yes	Intela-Traul
R/ALT232D	115/60/1	10.0	3790 @ -20°F Evap	R-404A	No	Yes	Yes	Intela-Traul
R/ARI132L	115/60/1	2.0	2400 @ +20°F Evap	R-134a	No	Yes	Yes	Intela-Traul
R/ARI232L	115/60/1	3.0	4360 @ +20°F Evap	R-134a	No	Yes	Yes	Intela-Traul
R/ARI332L	115/60/1	4.0	5330 @ +20°F Evap	R-134a	No	Yes	Yes	Intela-Traul
R/ARI132LP	115/60/1	3.0	2400 @ +20°F Evap	R-134a	No	Yes	Yes	Intela-Traul
R/ARI232LP	115/60/1	4.0	4360 @ +20°F Evap	R-134a	No	Yes	Yes	Intela-Traul
R/ARI332LP	115/60/1	5.0	5330 @ +20°F Evap	R-134a	No	Yes	Yes	Intela-Traul
R/ARI132H	115/60/1	2.0	2400 @ +20°F Evap	R-134a	No	Yes	Yes	Intela-Traul
R/ARI232H	115/60/1	3.0	4360 @ +20°F Evap	R-134a	No	Yes	Yes	Intela-Traul
R/ARI332H	115/60/1	4.0	5330 @ +20°F Evap	R-134a	No	Yes	Yes	Intela-Traul
R/AIF132L	115/60/1	7.5	2160 @ -20°F Evap	R-404A	No	Yes	Yes	Intela-Traul
R/AIF232L	115/60/1	11.0	5220 @ -20°F Evap	R-404A	No	Yes	Yes	Intela-Traul
R/AIF332L	208/115	12.0	7580 @ -20°F Evap	R-404A	No	Yes	Yes	Intela-Traul



TRAULSEN
4401 BLUE MOUND RD.
PHONE 1 (800) 825-8220
Website: www.traulsen.com

FT. WORTH, TX 76106
FAX-MKTG. 1 (817) 624-4302

Remote Refrigeration Data

Model No.	Voltage	Amps	BTU @ 90°F Ambient and Evap. Temp.	Cond. Evap.		Solenoid Yes/No	Exp. Valve Yes/No	Temp Control
				Refrigt	Yes/No			
R/ACV132W	115/60/1	7.5	2160 @ -10°F Evap	R-404A	No	Yes	Yes	No
R/ACV232W	115/60/1	10.0	1870 @ -10°F Evap	R-404A	No	Yes	Yes	No
R/ADT132EW	115/60/1	6.5	F-1850 @ -20°F Evap R-1130 @ +20°F Evap	R-404A R-134a	No	Yes	Yes	Intela-Traul
R/ADT132W	115/60/1	6.5	F-1850 @ -20°F Evap R-1130 @ +20°F Evap	R-404A R-134a	No	Yes	Yes	Intela-Traul
R/ADT232W	115/60/1	8.0	F-2170 @ -20°F Evap R-1730 @ -20°F Evap	R-404A R-134a	No	Yes	Yes	Intela-Traul
R/ADT332W	115/60/1	9.0	F-2160 @ -20°F Evap R-4360 @ +20°F Evap	R-404A R-134a	No	Yes	Yes	Intela-Traul
R/ADT232N	115/60/1	8.0	F-2170 @ -20°F Evap R-1730 @ +20°F Evap	R-404A R-134a	No	Yes	Yes	Intela-Traul
R/ADT332N	115/60/1	9.0	F-2160 @ -20°F Evap R-4360 @ +20°F Evap	R-404A R-134a	No	Yes	Yes	Intela-Traul
R/ADT132D	115/60/1	6.5	F-1850 @ -20°F Evap R-1130 @ +20°F Evap	R-404A R-134a	No	Yes	Yes	Intela-Traul
R/ADT232D	115/60/1	6.5	F-1850 @ -20°F Evap R-1130 @ +20°F Evap	R-404A R-134a	No	Yes	Yes	Intela-Traul
RDH232W	208/115-1-60	10.0	2400 @ +20°F Evap	R-134a	No	Yes	Yes	Intela-Traul
RDH232WP	208/115-1-60	10.0	2400 @ +20°F Evap	R-134a	No	Yes	Yes	Intela-Traul
RRI264L	115/60/1	4.0	2 X 4360 @ +20°F Evap	R-134a	No	Yes	Yes	Intela-Traul
RRI364L	115/60/1	8.0	2 X 5330 @ +20°F Evap	R-134a	No	Yes	Yes	Intela-Traul
RRI264LP	115/60/1	4.0	2 X 4360 @ +20°F Evap	R-134a	No	Yes	Yes	Intela-Traul
RRI364LP	115/60/1	8.0	2 X 5330 @ +20°F Evap	R-134a	No	Yes	Yes	Intela-Traul
RIF264L	208/115/60/1*	12.0	10,440 @ -20°F Evap	R-404A	No	Yes	Yes	Intela-Traul
RIF364L	208/115/60/1*	14.0	15,160 @ -20°F Evap	R-404A	No	Yes	Yes	Intela-Traul
RHT232NSL	115/60/1	6.5	5330 @ +20°F Evap	R-134a	No	Yes	Yes	Intela-Traul
RHT232NHG	115/60/1	2.0	4360 @ +20°F Evap	R-134a	No	Yes	Yes	Intela-Traul
TE036HR	115/60/1	3.2	2370 @ +20°F Evap	R-404A	Yes	Yes	Yes	Intela-Traul
TE048HR	115/60/1	3.3	2370 @ +20°F Evap	R-404A	Yes	Yes	Yes	Intela-Traul
TE060HR	115/60/1	3.5	2370 @ +20°F Evap	R-404A	Yes	Yes	Yes	Intela-Traul
TE065HR	115/60/1	3.5	2370 @ +20°F Evap	R-404A	Yes	Yes	Yes	Intela-Traul
TE072HR	115/60/1	3.6	2370 @ +20°F Evap	R-404A	Yes	Yes	Yes	Intela-Traul
TE084HR	115/60/1	3.7	2370 @ +20°F Evap	R-404A	Yes	Yes	Yes	Intela-Traul
TE096HR	115/60/1	3.9	4090 @ +20°F Evap	R-404A	Yes	Yes	Yes	Intela-Traul
TE110HR	115/60/1	4.0	4090 @ +20°F Evap	R-404A	Yes	Yes	Yes	Intela-Traul
TU044HR	115/60/1	3.3	3080 @ +20°F Evap	R-404A	Yes	Yes	Yes	Intela-Traul
TU072HR	115/60/1	3.7	3080 @ +20°F Evap	R-404A	Yes	Yes	Yes	Intela-Traul
TU100HR	115/60/1	3.9	3080 @ +20°F Evap	R-404A	Yes	Yes	Yes	Intela-Traul
TS048HR	115/60/1	9.8	3300 @ +10°F Evap	R-404A	Yes	Yes	Yes	Intela-Traul
TS066HR	115/60/1	10.2	3870 @ +10°F Evap	R-404A	Yes	Yes	Yes	Intela-Traul
TS072HR	115/60/1	10.2	3870 @ +10°F Evap	R-404A	Yes	Yes	Yes	Intela-Traul
TS090HR	115/60/1	10.4	3870 @ +10°F Evap	R-404A	Yes	Yes	Yes	Intela-Traul

NOTES:

- 1) Remote INTELA-TRAUL® equipped units do not require use of a temperature control.
- 2) Cord and plug are not supplied with remote units.
- 3) Listed BTU rating shown is the required BTU's delivered to the unit at the evaporator coil.
- 4) Compressor HP not supplied by Traulsen. Compressor size should be determined by a qualified refrigeration technician based on the delivered BTU rating at the unit and actual jobsite requirements.
- 5) To determine approximate remote model weights, please deduct 40 lbs. from the respective self-contained models net or gross weight.
- 6) Standard Traulsen five year compressor warranty does not apply to remote units.
- 7) Condensate Removal: except where noted above, all remote models require provisions to be made to allow for condensate removal. As supplied standard, these models include only a drain tube exiting the evaporator compartment on top of the cabinet from which condensate will drip. Optional condensate removal provisions include a drain line extended down the cabinet back (n/a for pass-thru or roll-thru models) or optional Top-Mounted Electric Condensate Evaporator.
Note: provision of the first option will add approximately 7/8" to the overall cabinet depth, while the latter will add approximately 1.5 amps to the cabinets full load amp rating. Cabinets built with optional TMCE's or BMCE's include arrangements to allow for these to be plugged directly into the unit.
- 8) Traulsen does not recommend the use of casters with remote models (legs supplied standard on G-Series remote units).
- 9) Refrigeration connections provided are 1/4" O.D. for the liquid line and either 1/2" or 3/4" O.D. for the suction line, no other connections are required.
- 10) The solenoid valve provided is wired at the factory directly to the control, and so no electrical connections are required between the unit and remote compressor.

Continued product development may necessitate specification changes without notice.

Part No. TR35837 (revised 1/13)

TRAULSEN
4401 BLUE MOUND RD.
PHONE 1 (800) 825-8220
Website: www.traulsen.com

FT. WORTH, TX 76106
FAX-MKTG. 1 (817) 624-4302

