

Project

Item #

Model Specified:

CSI Section 11400

Full Size Undercounter Refrigerators/ Self-Contained



One, Two & Three Door Models, 34" Deep

1-Door Refrigerator Model	TU044HT
2-Door Refrigerator Model	TU072HT
3-Door Refrigerator Model	TU100HT



Model TU072HT
(shown with optional stainless steel top and casters)

Traulsen's TU Series full size undercounter refrigerator models are designed for use with most applications, combining the advantages of modular flexibility with ease of maintenance. They are built to perform, their heavy duty construction, quality components and innovative design are all intended to provide a high quality, durable product you can depend upon.

Our undercounter models feature a door or drawer option. We've engineers our models with a drop-in feature that allows you to easily convert doors into two 6" deep drawers or three 4" deep drawers, making them ideal for any work area reorganization. Additionally, we meet the needs of today's food service operators by providing assured product holding temperatures, maximized storage capacity and features that assist with HACCP compliance, making them an excellent choice and value. That's Traulsen. Trusted.

Standard Product Features

- Stainless Steel Exterior & Interior
- INTELA-TRAUL[™] Microprocessor Control System
- Balanced, Self-Contained Refrigeration System Using R-404A
- Front-Breathing Design For "Zero-Clearance" Installation
- Non-Electric Automatic Condensate Evaporator
- Condenser Filter
- Off- Cycle Evaporator Defrost
- Stainless Steel Field Rehingable Door(s) With Locks
- Controllable Anti-Condensate Door Perimeter Heaters
- Metal Door Handle With Gasket Guard
- Self-Closing Doors With Stay Open Feature
- Standard Door Hinging: TU044HT = Right, TU072HT = Left/Right, TU100HT = Left/Left/Right (other hingings available)
- Two Wire Shelves Per Door (factory installed)
- Magnetic Snap-In Door Gaskets
- Gasket-Protecting Stainless Steel Door Liner
- Thermostatic Expansion Valve Metering Device
- Side, Front & Rear Access Panel For Ease of Service & Maintenance
- 9' Cord & Plug Attached
- 6" Legs On Adjustable Channel Moving System
- Three Year Parts And Labor Warranty
- Five Year Compressor Warranty

Options & Accessories

- Two (2) Drawers In Lieu Of One Or More Doors (accommodates 6" deep pans)
- Three (3) Drawers In Lieu Of One Or More Doors (accommodates 4" deep pans)
- Flat Stainless Steel Top With Bullnose Front
- Stainless Steel Top With 4" High Backsplash
- Stainless Steel Top With Drip Guard (marine) Edge
- Cabinet Length Extension Sections, Available In 3", 6", 9", 12" and 15" Sizes
- No. 1 Type Tray Slides To Accommodate either (1) 18" x 26" or (2) 14" x 18" Sheet Pans, Adjustable To 2" O.C.
- Universal Type Tray Slides To Accommodate either (1) 18" x 26", (2) 12" x 20" or (2) 14" x 18" Sheet Pans, Adjustable To 4" O.C.
- Additional Shelves
- Stainless Steel Shelves In Lieu of Standard Wire Shelves
- Export 220/50/1 Voltage
- NAFEM Data Protocol Gateway Package
- System Relocated To Right
- Set of 4-5/8" or 6" High Casters
- Remote Applications
- Remote For Use With 20°F Glycol System



Listed by Underwriters Laboratories Inc., to U.S. and Canadian safety standards and Listed by NSF International.

Approval: _____



TRAUlsen
4401 BLUE MOUND RD.
PHONE 1 (800) 825-8220
Website: www.traulsen.com

FT. WORTH, TX 76106
FAX-MKTG. 1 (817) 624-4302

Project	Quantity	Item #
Model Specified:		CSI Section 11400

Specifications

Construction, Hardware and Insulation

Cabinet exterior front, sides, one-piece louver assembly and doors are constructed of stainless steel. Cabinet interior and door liners are constructed of stainless steel. The exterior cabinet sub-top, back and bottom are constructed of heavy gauge aluminized steel. A set of adjustable 6" high stainless steel legs are included.

Doors are equipped with a gasket protecting metal door pan. A metal door handle with gasket guard is standard on all units.

Easily removable for cleaning, vinyl magnetic door gasket assures tight door seal. Anti condensate heaters are located behind each door opening.

Both the cabinet and door(s) are insulated with an average of 2" thick high density, non-CFC, foamed in place polyurethane.

Interior

Standard interior arrangements include two (2) wire shelves per door, mounted on shelf pins. Recommended load limit per shelf should not exceed 225 lbs. Optional tray slides may be purchased in combination with, or in lieu of these. Both standard and optional interior arrangements are completely installed at the factory.

Refrigeration System

The self-contained, balanced refrigeration system using R-404A refrigerant features a hot gas evaporator defrost, thermostatic expansion valve, air-cooled hermetic compressor, plenum effect blower coil, large, high humidity evaporator coil located outside the food zone and an electric condensate evaporator. A 9' cord and plug is provided. Standard operating temperature is 34 to 38°F.

DIMENSIONAL DATA	TU044HT	TU072HT	TU100HT
Net Capacity cu. ft.	9.8 (277 cu l)	20.0 (566 cu l)	30.1 (852 cu l)
Length Overall in.	44 (111.7 cm)	71 $\frac{3}{4}$ (182.2 cm)	100 (254 cm)
Depth - Cabinet Only in.	31 $\frac{1}{4}$ (79.4 cm)	31 $\frac{1}{4}$ (79.4 cm)	31 $\frac{1}{4}$ (79.4 cm)
Depth - with Door Open 90°	58 $\frac{13}{16}$ (149.4 cm)	58 $\frac{13}{16}$ (149.4 cm)	58 $\frac{13}{16}$ (149.4 cm)
Depth - Overall in.	34 (86.4 cm)	34 (86.4 cm)	34 (86.4 cm)
Height - Overall on 6" Legs in. ¹	33 $\frac{7}{10}$ (85.6 cm)	33 $\frac{7}{10}$ (85.6 cm)	33 $\frac{7}{10}$ (85.6 cm)
Height - Overall on 6" Legs in. ²	34 (86.4 cm)	34 (86.4 cm)	34 (86.4 cm)
Net Weight-uncrated lbs. ³	390	560	730
Number of Shelves	2	4	6
Shelf Area sq. ft.	8.2 (.8 sq. m.)	18.1 (1.7 sq. m.)	28.3 (2.6 sq. m.)
ELECTRICAL DATA			
Voltage	115/60/1	115/60/1	115/60/1
Full Load Amperes	6.3	6.3	6.3
NEMA Plug Type	5-15P	5-15P	5-15P
REFRIGERATION DATA			
Refrigerant	R-404A	R-404A	R-404A
BTU/HR - HP ⁴	2440 ($\frac{1}{3}$ HP)	2440 ($\frac{1}{3}$ HP)	2440 ($\frac{1}{3}$ HP)

NOTES

NOTE: Figures in parentheses reflect metric equivalents.

- 1= Height as measured without optional stainless steel work top.
- 2= Height as measured with optional stainless steel work top.
- 3= For shipping weights and dimensions please refer to form TR35875.
- 4= Based on a 90 degree F ambient and 20 degree F evaporator. For information on remote models, please refer to form TR35837.



Equipped With One NEMA 5-15 P Plug

NOTE: An optional stainless steel worktop is required on full size undercounter models being used to support equipment weighing in excess of 100 lbs. or producing heat in excess of 140°F to the top surface.

NOTE: When ordering please specify: Voltage, Hinging, Options and any additional warranties.

Continued product development may necessitate specification changes without notice.

Part No. TR35774 (revised 1/13)

Controller

The easy to use water resistant INTELA-TRAUL[®] microprocessor control system is supplied standard. Unit is NAFEM Data Protocol communication (NDP) ready. Optional hardware required to be NDP compliant. Third party software required for network connection. It includes a 3-Digit LED Display, Fahrenheit or Celsius Temperature Scale Display Capability, and an RS485 data port. In addition it includes audio/visual alarms for: Hi/Lo Cabinet Temperature, Clean Condenser, Evaporator Coil and Discharge Line Sensor Failures, and Power Supply Interruption.

Warranties

Both a three year parts and labor warranty and a five year compressor warranty (self-contained models only) are provided standard.

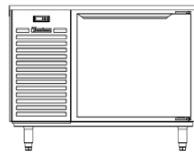

Elevation - TU044HT

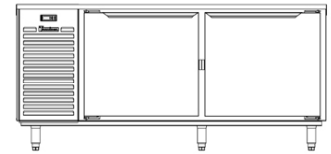

Elevation - TU072HT

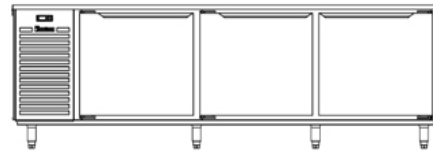

Elevation - TU100HT

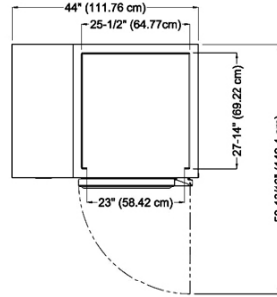

Plan - TU044HT

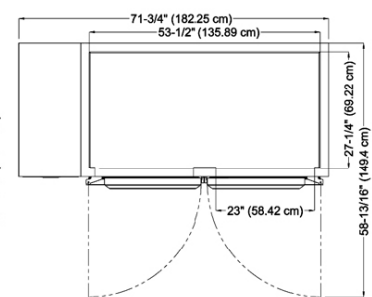

Plan - TU072HT

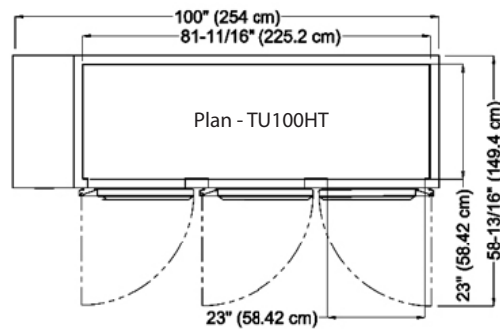

Plan - TU100HT

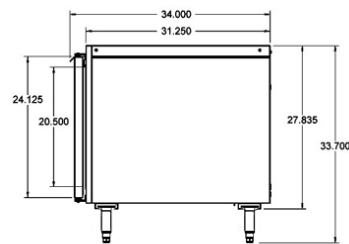

Section - All Models

TRAULSEN
4401 BLUE MOUND RD.
PHONE 1 (800) 825-8220
Website: www.traulsen.com

FT. WORTH, TX 76106
FAX-MKTG. 1 (817) 624-4302

