



Your Solutions Partner

Specifications

F.O.B Sedalia, Missouri 65301



838

OPTIONS:

- Radiant Heat Rods (HT) Specify Voltage
- Fluorescent Lights (FL)
- Bullet-type Heat Lamps (BL)
- Bullet-type incandescent lights (BI)
- Special lengths
- Special guards
- Heater with incandescent lights
- Powder coat painted frames & shelf

Approval Stamp(s):

PRODUCT INFORMATION:

PROJECT: _____

ITEM: _____

QUANTITY: _____

MODEL: Foodshield - Deluxe Buffet Shelves

Fits: Aeroheat & Thurmaduke Steamtables, Heritage, Economate, Aeroserv Serving Systems

- 836 / 836-1SN
- 837 / 837-1SN
- 838 / 838-1SN Deluxe Buffet Shelves
- 839 / 839-1SN
- 840 / 840-1SN

FRAMES:

- 3/4" square stainless steel tube

GUARDS:

- 1/4" tempered glass guard with stainless steel trim
- Self-service style
- Clear acrylic enclosure both ends

SIZES:

- All units available in following lengths
30-7/32", 44-7/32", 58-7/32", 72-7/32", 86-7/32"

SHELF:

- Heavy gauge stainless steel with edges flanged down

Agency Listings:



DUKE MANUFACTURING CO.
2305 N. Broadway
St. Louis, MO 63102

800.735.3853 Toll Free
314.231.5074 Fax
www.dukemfg.com

SHORT FORM SPECIFICATIONS:

Foodshield -83x Series Deluxe buffet shelves shall be constructed of heavy gauge stainless steel, with edges flanged down and supported on formed, 3/4" square stainless steel tubular brackets. These shelves shall be 10-1/2" wide. Shelves shall extend 20" above counter surface. The guards are glass and will clear top by 12", permitting easy self-service of food.

NSF Updates: (1) Bracket height and length change. (2) Front glass height change (3) End guard height change. (4) Added side shield.

FOODSHIELD - BUFFET SHELVES

- 836 / 836-1SN
- 837 / 837-1SN
- 838 / 838-1SN Deluxe Buffet Shelves
- 839 / 839-1SN
- 840 / 840-1SN

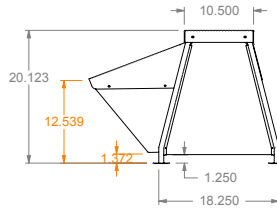
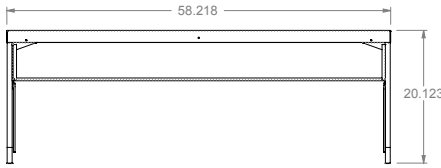
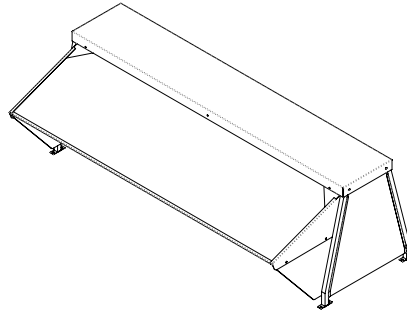
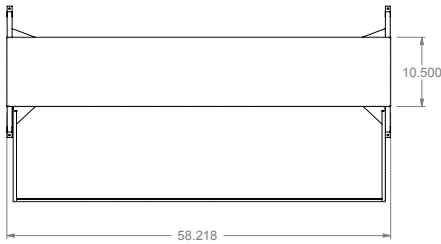

ONE SIDE

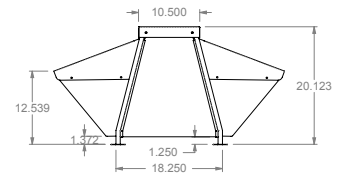
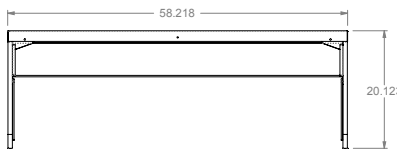
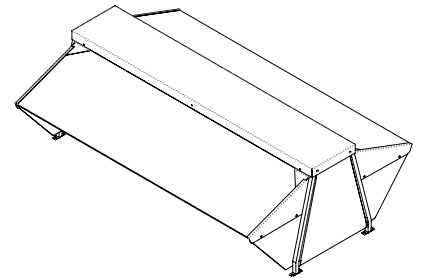
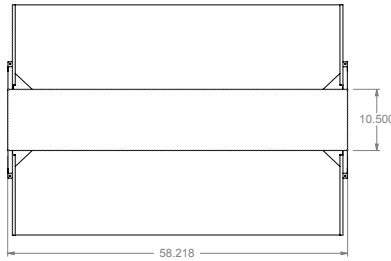

BOTH SIDES

DIMENSIONS:
Deluxe Buffet Shelves

Freight Class: 85

Model	Length		Shelf Width		Height		Cube ft. Crated	Weight	
	in.	cm	in.	cm	in.	cm		lbs.	kg
836 / 836-1SN	30-7/32	76.8	10-1/2	26.7	20	50.8	8.6	40	18.2
837 / 837-1SN	44-7/32	112.3	10-1/2	26.7	20	50.8	11.8	48	21.8
838 / 838-1SN	58-7/32	147.9	10-1/2	26.7	20	50.8	15.1	68	30.9
839 / 839-1SN	72-7/32	183.4	10-1/2	26.7	20	50.8	18.4	98	44.6
840 / 810-1SN	86-7/32	219.0	10-1/2	26.7	20	50.8	21.5	118	53.5



DUKE MANUFACTURING CO.

2305 N. Broadway
St. Louis, MO 63102

800.735.3853 Toll Free
800.231.1130 In Missouri
314.231.5074 Fax
www.dukemfg.com

Specification subject to change