



Profit from the Eagle Advantage®

Specification Sheet

Short Form Specifications

Eagle Spec-Bar® Removable Single Speed Rail, model _____. Heavy gauge type 304 stainless steel construction with ABS for sound deadening. Available in keyhole style or hanging style.



hanging speed rail

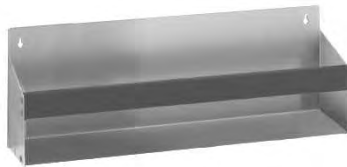

keyhole speed rail

Item No.:	_____
Project No.:	_____
S.I.S. No.:	_____

Spec-Bar® Removable Single Speed Rails

MODELS:

- | | |
|---------------------------------|---------------------------------|
| <input type="checkbox"/> KSR-12 | <input type="checkbox"/> HSR-12 |
| <input type="checkbox"/> KSR-18 | <input type="checkbox"/> HSR-18 |
| <input type="checkbox"/> KSR-24 | <input type="checkbox"/> HSR-24 |
| <input type="checkbox"/> KSR-30 | <input type="checkbox"/> HSR-30 |
| <input type="checkbox"/> KSR-36 | <input type="checkbox"/> HSR-36 |

Design and Construction Features

- Type 304 stainless steel construction for strength and corrosion resistance.
- Bottom and front are 20 gauge stainless steel.
- Sides are 14 gauge stainless steel.
- Designed with ABS sound deadening covers to soften sound.
- Add to existing Spec-Bar® speed rails and vertical surfaces with two types of speed rails available.
- Increase brand recognition by storing bottles in these easy-to-clean speed rails.

EAGLE GROUP
 100 Industrial Boulevard, Clayton, DE 19938-8903 USA
 Phone: 302-653-3000 • Fax: 302-653-2065
 www.eaglegrp.com

Foodservice Division: Phone 800-441-8440
MHC/Retail Display Divisions: Phone 800-637-5100

For custom configuration or fabrication needs, contact our **SpecFAB® Division**.
 Phone: 302-653-3000 • Fax: 302-653-3091 • e-mail: specfab@eaglegrp.com



EG40.51 Rev. 04/11

Spec sheets available for viewing, printing or downloading from our online literature library at www.eaglegrp.com

Eagle Foodservice Equipment, Eagle MHC, SpecFAB®, and Retail Display are divisions of Eagle Group. ©2011 by the Eagle Group

KaTom Restaurant Supply, Inc.



Profit from the Eagle Advantage®

Item No.: _____
 Project No.: _____
 S.I.S. No.: _____

Spec-Bar® Removable Single Speed Rails

Keyhole Speed Rails – for attaching onto existing equipment

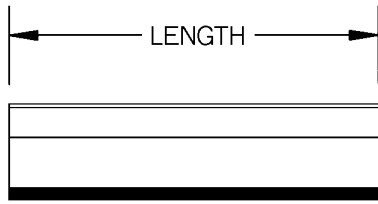

TOP VIEW

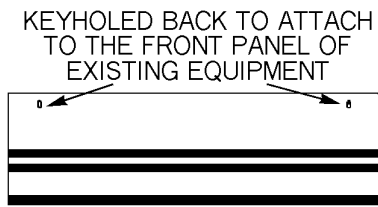
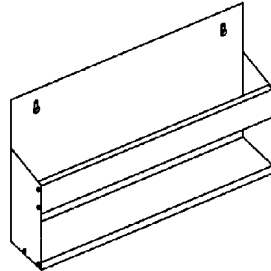

FRONT VIEW

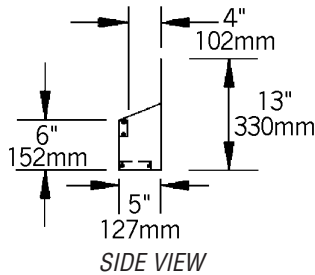

model #	width		length		weight	
	in.	mm	in.	mm	lbs.	kg
KSR-12	5"	127	12"	305	4	1.8
KSR-18	5"	127	18"	457	6	2.7
KSR-24	5"	127	24"	610	7	3.2
KSR-30	5"	127	30"	762	10	3.5
KSR-36	5"	127	36"	914	12	5.4

Hanging Speed Rails – for clipping onto existing single speedrails

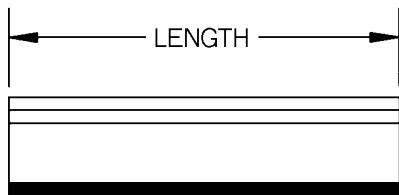

TOP VIEW

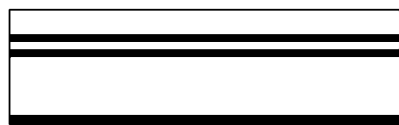
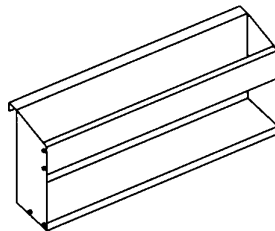

FRONT VIEW

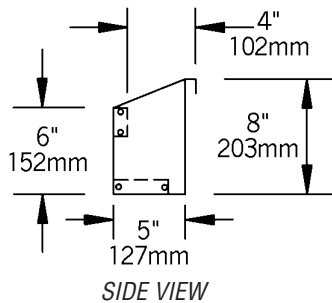

model #	width		length		weight	
	in.	mm	in.	mm	lbs.	kg
HSR-12	5"	127	12"	305	4	1.8
HSR-18	5"	127	18"	457	6	2.7
HSR-24	5"	127	24"	610	7	3.2
HSR-30	5"	127	30"	762	10	3.5
HSR-36	5"	127	36"	914	12	5.4

EAGLE GROUP
 100 Industrial Boulevard, Clayton, DE 19938-8903 USA
 Phone: 302-653-3000 • Fax: 302-653-2065
 www.eaglegrp.com

Foodservice Division: Phone 800-441-8440
 MHC/Retail Display Divisions: Phone 800-637-5100

Printed in U.S.A.
 ©2011 by Eagle Group

Rev. 04/11

Spec sheets available for viewing, printing or downloading from our online literature library at www.eaglegrp.com

Although every attempt has been made to ensure the accuracy of the information provided, we cannot be held responsible for typographical or printing errors. Information and specifications are subject to change without notice. Please confirm at time of order.