



KOLD LOCKER™ WALK-INS



Standard Model Coolers and Freezers In Stock for SAME DAY SHIPMENT

STANDARD FEATURES

- STANDARD MODELS SHIP THE SAME DAY*
- Cooler or freezer models
- Sizes from 3'6" x 6' to 10' x 14'
- Three heights: 6'7" & 7'7" with floor; 7'4" floorless
- Indoor or outdoor models
- Three temperatures: +35°F, -10°F, -20°F (-20°F *)
- Capsule Pak™ refrigeration system (ceiling or wall mount) (ordered separately)
- Air-cooled condensing unit (wall mount -- 10 day ship)
- Automatic condensate vaporizer. No drain line required on indoor units
- Time clock provided for automatic defrost on both coolers and freezers
- 26 gauge corrosion resistant stucco embossed coated steel on all surfaces except interior floor
- Smooth aluminum interior floor (on models with floor)
- Floorless models supplied with NSF listed vinyl sealers
- Full 4" thick panels foamed-in-place with EPA-compliant polyurethane insulation
- 26" wide, self-closing door
- Heavy duty adjustable cam-lift hinges
- Spring actuated door closer
- Deadbolt locking handle with independent key/padlock feature and inside safety release
- Magnetic gasket
- Digital thermometer and light switch
- Floor double sweep gasket
- Perimeter door heater wire
- High output low profile LED light positioned above the door to prevent interference with shelving or product
- NSF, UL flame spread 25 on all panels; UL and CSA electrical listing on door sections ***
- UL, C-UL listing on complete Capsule Pak™ refrigeration systems ***
- City of Houston listed
- California State listed
- CN UL flame spread approval
- DOE compliant
- Oregon State listed

- USDA accepted
- Registered by UL to ISO 9001:2008
- 15 year panel warranty
- 18 months parts & labor warranty

INDOOR MODELS:

- Hot gas condensate vaporizer

OUTDOOR MODELS:

- White membrane roof and trim
- Refrigeration hood
- -20°F ambient controls

OPTIONAL FEATURES**

- U-shaped shelving system
- Alarm/light management system
- Floor tread plate kit
- Exterior ramp
- Condensing unit air deflector kit
- Door hood (outdoor models)
- Heater kit for cooler located outdoors in below +32°F ambient
- Leak detector / alarm (may be a requirement in some areas)
- Three phase electrical
- Remote Capsule Pak™ refrigeration systems
- 5" thick panel models available - additional lead time required
- 220/50/1 electrical
- Heights: 8'7" with floor, 8'4" without floor
- Electric vaporizer (for Remote Capsule Pak™ applications)
- Five year compressor warranty



Nor-Lake, Inc.
Registered to ISO 9001:2008
File No. 10001816

* Some models ship in 5 or 10 days

** Most options are available two weeks from receipt of order. Please contact us for specific questions.

*** C-UL is Underwriters Laboratories Safety Certification Mark which indicates that UL has tested the equipment to applicable CSA Standards.

*** UL Sanitation is Underwriters Laboratories Sanitation Mark which indicates that UL has tested the equipment to applicable NSF Standards.

WALK-IN SPECIFICATIONS

Kold Locker™ walk-ins are built of modular panels, and are insulated with foamed-in-place EPA-compliant polyurethane insulation. Each panel is designed to ensure ease of installation, long term reliability and high insulating efficiency.

A. All panels are manufactured with male and female mating rails to ensure proper alignment during installation. The polyurethane insulation wraps around the return bend metal seams on both section to create a lightweight panel of exceptional strength and durability. All panels are a full four (4) inches thick and provide a superior insulating value. The foamed-in-place cam locking fasteners ensure an airtight seal for maximum energy efficiency.

B. The foamed-in-place cam locking fasteners ensure an airtight seal for maximum energy efficiency.

C. Kold Locker™ panel gaskets around the outer perimeter of the panel are continuous, without cuts or breaks at corners. The Nor-Lake patented gasket design provides a foamed-in-place gasket as an integral part of the panel. Gaskets cannot fall off or pull off during shipment or installation.

D. Panels lock together tightly to assure an energy efficient walk-in.

E. Edge caps for ends of floor and ceiling panels are foamed-in-place rather than overlapped or mechanically fastened. Edge caps cannot come loose, and they stay in place through the life of the walk-in.

F. Panel Finishes: Interior and exterior complete to be 26 gauge corrosion resistant stucco embossed coated steel. Models supplied with a floor will include a smooth aluminum interior floor surface.

Insulation: Panels to be four (4) inches thick, metal clad and foamed-in-place with HFC-245fa polyurethane insulation which is CFC and HCFC free.

Mini Kold Locker™ Walk-ins 3'6" x 6'0" x 6'7" and 3'6" x 7'0" x 6'7"

Similar floor space as 3 door reach-in. Modular easy to get into existing building, through doors and hallways. 20%-30% more capacity than 3 door reach-in.

Expanded Kold Locker™ Coolers:

Now available in three larger sizes!

10' x 10'
10' x 12'
10' x 14'

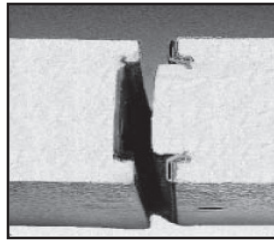

A.

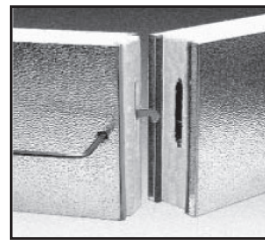

B.

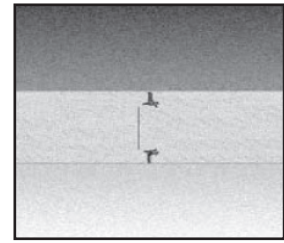

C.

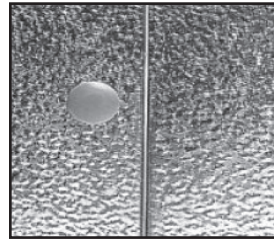

D.

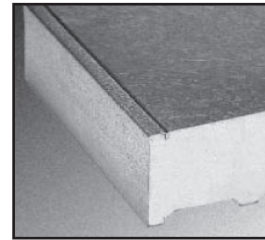

E.

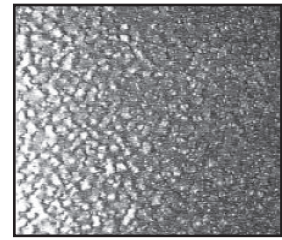

F.

KOLD LOCKER™ SINGLE ROOM COOLERS OR FREEZERS FLOOR PLAN LAYOUTS

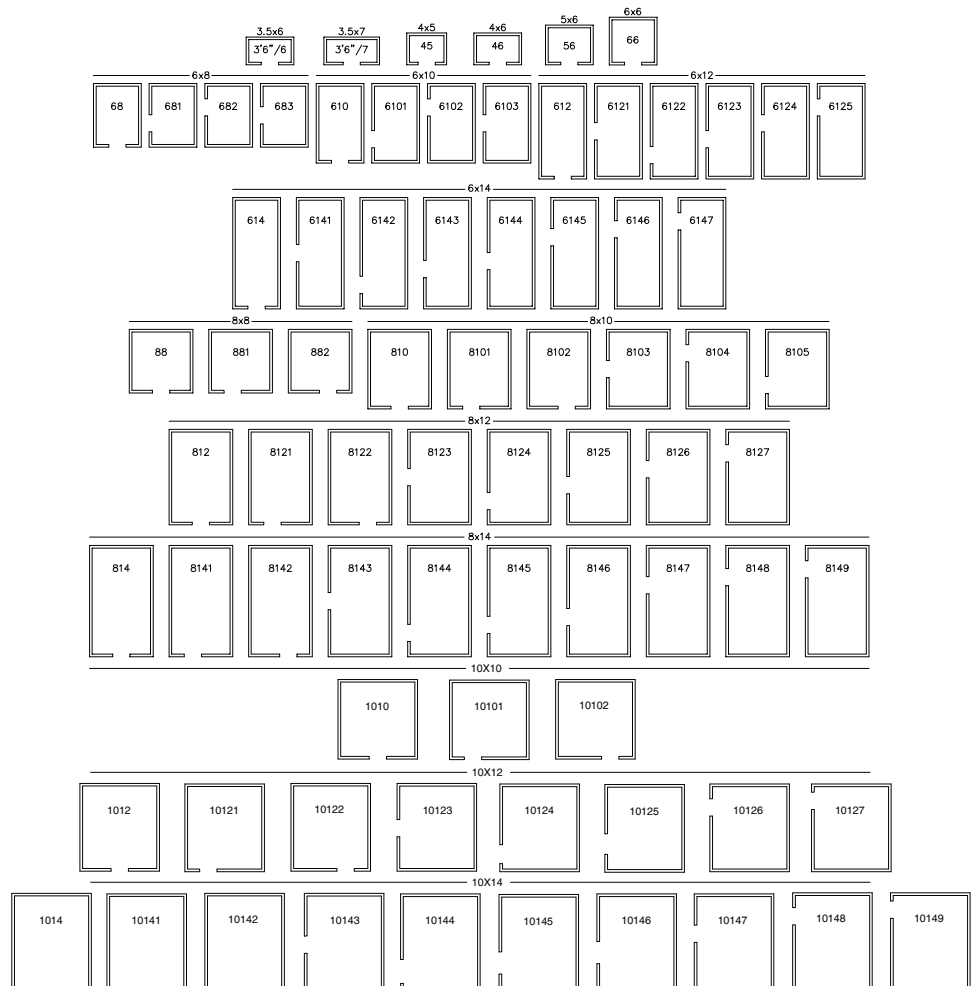

DOOR

Door sections manufactured at Nor-Lake are factory tested to assure proper fit, performance and alignment. All doors feature a stepped profile design that serves as a barrier to air flow which results in an energy efficient door system. Door sections are 4" thick, metal clad and foamed-in-place with EPA-compliant polyurethane insulation.

Each Kold Locker™ walk-in compartment is equipped with a 26" wide door opening. The height of the door opening varies with the series of Kold Locker™ walk-in ordered. The 45 Series has a 59" high door, the Standard Series (6'7" high) has a 66" high door opening and the 74 and 77 Series Kold Locker™ walk-ins have a 78" high door opening. The door is self-closing, flush mounted, infitting and constructed to incorporate heavy duty, molded ABS breaker which is permanently foamed-in-place.

Doors are available with right or left side hinges and include two field adjustable cam-lift hinges with locking set screw, top hinge spring loaded, spring actuated door closer, NL 9800 deadbolt locking handle with independent key/padlock feature and inside safety release. The doors are pre-hung in a four foot wide frame panel which is equipped with replaceable perimeter heater wire, magnetic stainless steel trim, digital thermometer, vapor proof LED light fixture and switch with exterior pilot indicator light.

The door section is completely pre-wired within concealed conduit inside the door frame panel. 115/60/1 electrical is field wired to a junction box which is surface mounted next to the interior frame above the vapor proof LED light fixture.

Hinges and door handle are mounted to 1/2" synthetic insulated tapping plates. Each door section is complete with a fiberglass reinforced plastic heated threshold.

FLOOR CONSTRUCTION

Floor panels (when supplied) are similar in construction to the wall panels except they are made to withstand uniformly distributed floor loads of up to 800 pounds per square foot. The interior floor metal is smooth aluminum.

The 74 Series, floorless models, are supplied with a patented vinyl floor sealer to stop conductivity at floor level. This unique sealer sits flat on existing floors and fits tightly against the interior/exterior wall panels. The walk-in wall panel is supported on the shoulder of the sealer so the foam edge is free of compressing weight. The vinyl floor sealer is NSF listed.

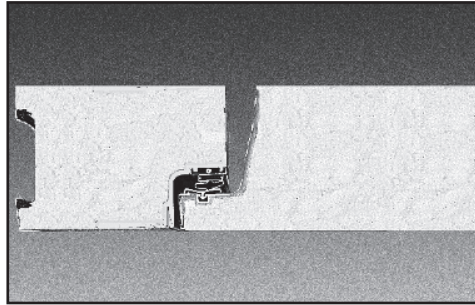

DOORS FEATURE A STEPPED PROFILE DESIGN

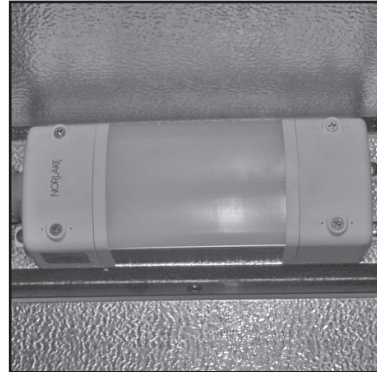

LED LIGHT FIXTURE



**DIGITAL THERMOMETER/
LIGHT SWITCH**

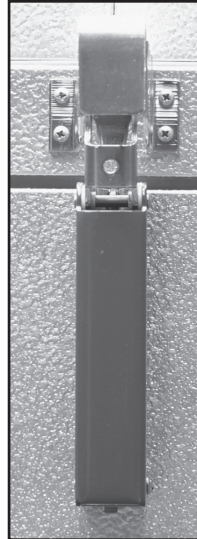

**SPRING ACTUATED
DOOR CLOSER**

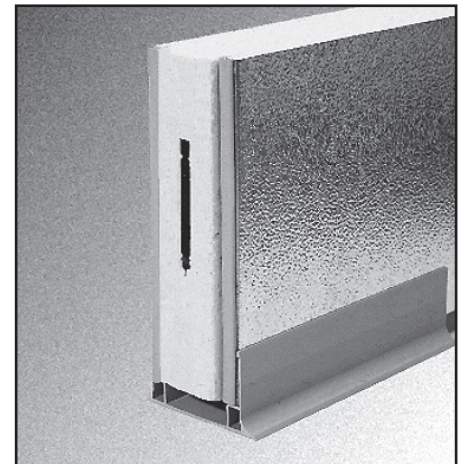

**FLOORLESS MODELS ARE
SUPPLIED WITH A PATENTED
VINYL FLOOR SEALER**



DEADBOLT LOCKING HANDLE

CAPSULE PAK™ REFRIGERATION SYSTEMS

KOLD LOCKER™ MODEL	+38°F to +35°F		-10°		-20°	
	CEILING	WALL	CEILING	WALL	CEILING	WALL
6'0" HIGH						
KL45	050	050	060	060	N/A	N/A
KL366	050	050	050	060	N/A	N/A
KL367	050	050	050	060	N/A	N/A
KL46	050	050	060	060	100	100
KL 56	050	050	075	075	100	100
KL66	050	050	075	075	100	100
KL68	050	050	100	100	150	150
KL610	050	050	100	100	150	150
KL612	075	075	150	150	150	150
KL614	100	N/A	N/A	N/A	N/A	N/A
KL88	050	050	100	100	150	150
KL810	075	075	150	150	150	150
KL812	100	N/A	150	N/A	N/A	N/A
KL814	100	N/A	151	N/A	N/A	N/A
KL1010	100	N/A	151	N/A	N/A	N/A
KL1012	100	N/A	151	N/A	N/A	N/A
KL1014	100	N/A	151	N/A	N/A	N/A
7'7" HIGH WITH FLOOR						
KL7746	050	050	075	075	N/A	N/A
KL7748	050	N/A	100	N/A	N/A	N/A
KL7756	050	050	100	100	150	150
KL7766	050	050	100	100	150	150
KL7768	050	050	100	100	150	150
KL77610	075	075	150	150	150	150
KL77612	075	075	150	150	151	150
KL77614	100	N/A	N/A	N/A	N/A	N/A
KL7788	075	075	150	150	150	150
KL77810	075	075	150	150	151	150
KL77812	100	N/A	150	N/A	N/A	N/A
KL77814	100	N/A	151	N/A	N/A	N/A
KL771010	100	N/A	151	N/A	N/A	N/A
KL771012	100	N/A	151	N/A	N/A	N/A
KL771014	100	N/A	151	N/A	N/A	N/A
7'4" HIGH LESS FLOOR						
KL7446	050	050	N/A	N/A	N/A	N/A
KL7456	050	050	N/A	N/A	N/A	N/A
KL7466	050	050	N/A	N/A	N/A	N/A
KL7468	075	075	N/A	N/A	N/A	N/A
KL74610	075	075	N/A	N/A	N/A	N/A
KL74612	075	075	N/A	N/A	N/A	N/A
KL74614	100	N/A	N/A	N/A	N/A	N/A
KL7488	075	075	N/A	N/A	N/A	N/A
KL74810	075	075	N/A	N/A	N/A	N/A
KL74812	100	N/A	N/A	N/A	N/A	N/A
KL74814	100	N/A	N/A	N/A	N/A	N/A
KL741010	100	N/A	N/A	N/A	N/A	N/A
KL741012	100	N/A	N/A	N/A	N/A	N/A
KL741014	100	N/A	N/A	N/A	N/A	N/A
6'7" HIGH WITH FLOOR OUTDOOR						
KOD45	050	050	060	060	N/A	N/A
KOD46	050	050	075	075	N/A	N/A
KOD56	050	050	075	075	N/A	N/A
KOD66	050	050	100	100	N/A	N/A
KOD68	075	075	100	100	N/A	N/A
KOD610	075	075	150	150	N/A	N/A
KOD612	075	075	150	150	N/A	N/A
KOD614	100	N/A	N/A	N/A	N/A	N/A
KOD88	075	075	150	150	N/A	N/A
KOD810	075	075	150	150	N/A	N/A
KOD812	100	N/A	151	N/A	N/A	N/A
KOD814	100	N/A	151	N/A	N/A	N/A
KOD1010	100	N/A	151	N/A	N/A	N/A
KOD1012	100	N/A	151	N/A	N/A	N/A
KOD1014	100	N/A	200	N/A	N/A	N/A
7'7" HIGH WITH FLOOR OUTDOOR						
KOD7746	075	075	075	075	N/A	N/A
KOD7756	075	075	100	100	N/A	N/A
KOD7766	075	075	100	100	N/A	N/A
KOD7768	075	075	150	150	N/A	N/A
KOD77610	075	075	150	150	N/A	N/A
KOD77612	075	075	150	150	N/A	N/A
KOD77614	100	N/A	N/A	N/A	N/A	N/A
KOD7788	075	075	150	150	N/A	N/A
KOD77810	075	075	151	151	N/A	N/A
KOD77812	100	N/A	151	N/A	N/A	N/A
KOD77814	100	N/A	200	N/A	N/A	N/A
KOD771010	100	N/A	151	N/A	N/A	N/A
KOD771012	100	N/A	200	N/A	N/A	N/A
KOD771014	100	N/A	200	N/A	N/A	N/A

PHYSICAL SPECIFICATIONS

6'7" HIGH

<u>Unit Interior</u>	<u>Cubage</u>
KL45 (6'0" High)	77
KL46	105
KL56	137
KL66	168
KL68	231
KL610	295
KL612	357
KL614	420
KL88	318
KL810	404
KL812	490
KL814	578
KL1010	515
KL1012	625
KL1014	736

7'4" HIGH & 7'7" HIGH

<u>Unit Interior</u>	<u>Cubage</u>
KL7745	100
KL7746	123
KL7756	159
KL7766	196
KL7768	270
KL77610	344
KL77612	418
KL77614	490
KL7788	372
KL77810	473
KL77812	574
KL77814	675
KL771010	602
KL771012	731
KL771014	860

Door Opening Size

<u>W</u>	<u>H</u>	<u>Model</u>
26"	59"	45 Series
26"	66"	STD Series
26"	78"	74 Series
26"	78"	77 Series

KOLD LOCKER™ WALK-IN SIZES AVAILABLE

The **45 Series** is available in one size which is 4' wide x 5' long x 6'-0" high. This model is supplied with a walk-in floor. This series ships in 5 days.

The **Standard Series** of Kold Locker™ walk-ins are all 6'-7" high and are all supplied with a floor. The sizes available are as follows: 4' wide x 6' long, 6' wide x 6' long, 6' wide x 8' long, 6' wide x 10' long, 6' wide x 12' long, 8' wide x 8' long, and 8' wide x 10' long.

The **77 Series** of Kold Locker™ walk-ins are all 7'-7" high and are all supplied with a floor. The sizes available are as follows: 6' wide x 6' long, 6' wide x 8' long, 6' wide x 10' long, 6' wide x 12' long, 8' wide x 8' long, and 8' wide x 10' long.

The **74 Series** of Kold Locker™ walk-ins are all 7'-3 5/8" high and are all supplied without a floor. Wall panels are installed on top of NSF listed vinyl sealers provided. The sizes available are as follows: 6' wide x 6' long, 6' wide x 8' long, 6' wide x 10' long, 6' wide x 12' long, 8' wide x 8' long, and 8' wide x 10' long.

OUTDOOR MODELS:

All Kold Locker™ walk-ins installed outdoors include a weather protection kit consisting of: One piece, 35 mill, white membrane roof material which requires no seaming or gluing to the top of the Kold Locker™ walk-in ceiling panels.

Metal trim for flashing the membrane roof material to the side of the Kold Locker™ walk-in wall panels are included.

Trim is secured to the Kold-Locker™ wall panels with self-drilling and self-tapping TEK screws. In applications where the Kold Locker™ walk-in is installed next to a building, the trim can be used to secure the turned up membrane roof material to the building wall, with fasteners supplied. Door rain hoods are an option and should be included on installations where the door panels are exposed to the outdoor weather.

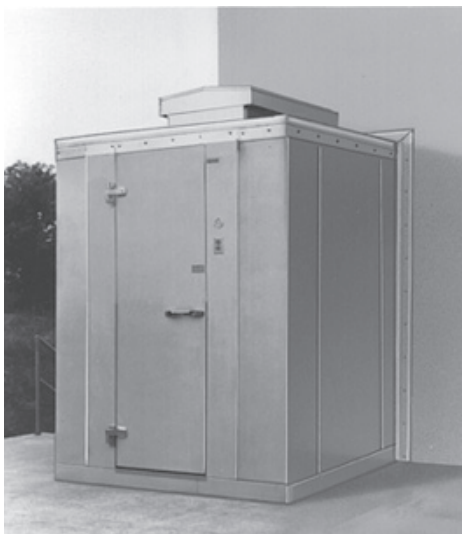

SHELVING KITS

Shelving kits specifically designed for each Kold Locker™ walk-in configuration are offered as an optional extra. These kits are shipped with the Kold Locker™ walk-in and Capsule Pak™ refrigeration system so that all necessary components are at your location promptly when you need them. The shelving sets are coded to correspond to the Kold Locker™ walk-in configuration ordered and are offered in either three or four tier.

TWO TYPES OF SHELVING SYSTEMS ARE AVAILABLE FROM NOR-LAKE.

A. Green Kote™ Shelving: Electrostatically applied green baked epoxy over zinc steel and brite basic wire. Thickness: 2-3 mill. 15 year guarantee against corrosion.

B. Nor-Lake Standard Chrome Kote™ Shelving: Plated quality wire and steel. Surface nickel chrome plated.

Select the shelving FINISH of your choice. Shelving posts are engineered for maximum strength. Shelves are adjustable on 2" centers. All shelves are NSF listed and are zinc coated with a heavy layer of Protoxy for a maximum life span under humid storage conditions. Special clips are utilized to gain the maximum square footage of storage space for each Kold Locker™ model. 14", 18" and 24" wide shelves are used as required for maximum storage capacity in each set. This wire shelving is ideal for storage of all refrigerated or frozen products.

SHELVES:

Shelves to have #9 (.148") gauge crosswires spaced 3/4" on centers with crossbraces 1/4" (.192") minimum of 4-3/4" on center.

Shelf Frames

Channel to be 9/16" x 1" x .075" thick.

Shelf Collars

A round tapered 1-5/16" high steel collar to be welded at each corner.

POSTS

Posts to be .062" thick 1" O.D. round tubing notched every 2" on each corner of the post.

POST LEVELERS

Installed on the bottom of each post is nylon housing for a steel leveler 3/8"-16 x 1-3/4".

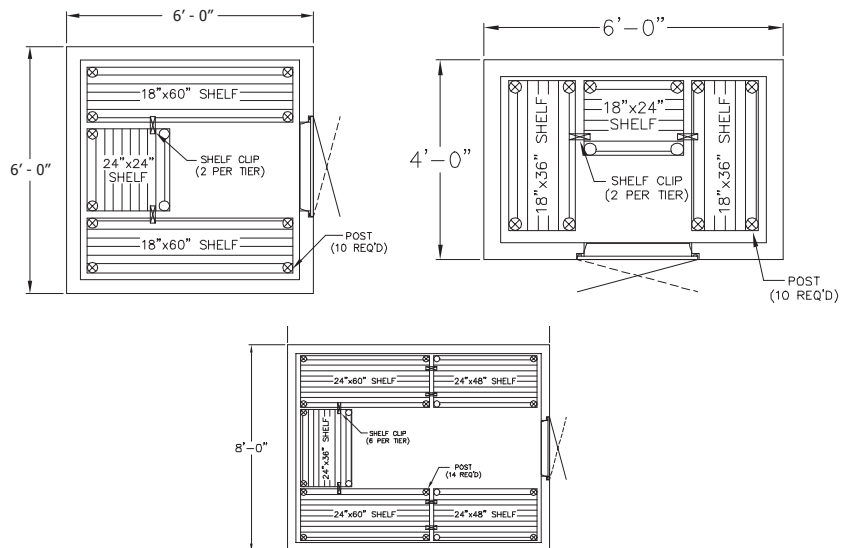

NOR-LAKE, INCORPORATED
 727 Second Street
 Hudson, Wisconsin 54016
 800-955-5253 Sales
 715-386-2323 Sales
 800-961-5253 Parts
 800-388-5253 Service
 715-386-4291 FAX
 www.norlake.com

ISO 9001:2008
 Registered to ISO 9001:2008
 File No. 10001816



NORLAKE®

Revision Date: 01/16
 ©2016 Nor-Lake, Inc.
 Printed in the U.S.A.
 Part Number: 079297