

Indigo™ Series 1400 Ice Cube Machine

Model: ID-1402A ID-1403W ID-1492N
 IY-1404A IY-1405W IY-1494N



Indigo Series i-1400
Ice Machine on B-970 Bin

Designed for operators who know that ice is critical to their business, the Indigo™ Series ice machine's preventative diagnostics continually monitor itself for reliable ice production. Improvements in cleanliness and programmability make your ice machine easy to own and less expensive to operate.

- **Space-Saving Design** – Up to 1,550 lbs. (705 kgs.) daily ice production and only 48" (121.92 cm) wide.
- **Intelligent Diagnostics** – provide 24 hour preventative maintenance and diagnostic feedback for trouble free operation.
- **Acoustical Ice Sensing Probe** – for reliable operation in challenging water conditions.
- **EasyRead Display** – communicates operating status, cleaning reminders, and asset information through a blue illuminated display.
- **Programmable Ice Production** – by On/Off Time, Ice Volume or Bin Level (with accessory bin level control) further improves energy efficiency and savings.
- **Easy to Clean Foodzone** – Hinged front door swings out for easy access. Removable water-trough, distribution tube, curtain, and sensing probes for fast and efficient cleaning. Select components made with AlphaSan® antimicrobial.
- **DuraTech™ Exterior** – provides superior corrosion resistance. Stainless finish with innovative clear-coat resists fingerprints and dirt.
- Available **LuminIce™ Growth Inhibitor** controls the growth of bacteria and yeast within the foodzone.

Ice Machine Electric

208-230/60/1 standard
(208-230/60/3 and 230/50/1 also available.)

Minimum circuit ampacity:

Air-cooled:	18.3 1ph	13.2 3ph
Water-cooled:	16.9 1ph	11.8 3ph
Remote-cooled:	17.9 1ph	12.8 3ph

Maximum fuse size:

Air-cooled:	30 1ph	20 3ph
Water-cooled:	30 1ph	20 3ph
Remote-cooled:	30 1ph	20 3ph

Specifications

BTU Per Hour:

23,500 (average)
27,000 (peak)

Refrigerant:

R-404A CFC-free

Operating Limits:

- Ambient Temperature Range: 35° to 110°F (1.7° to 43.3°C)
Water Temperature Range: 35° to 90°F (1.7° to 32.2°C)
- Water Pressure Ice Maker Water In:
Min. 20 psi (137.9 kPa)
Max. 80 psi (551.1 kPa)



Ice Shape



Half Dice
3/8" x 1 1/8" x 7/8"
(.95 x 2.86 x 2.22 cm)



Dice
7/8" x 7/8" x 7/8"
(2.22 x 2.22 x 2.22 cm)





Indigo™ Series 1400 Ice Cube Machine

i-1400 on B-970 Storage Bin

Installation Note

Air Cooled clearance:

Top: 24" (61.0 cm)

Sides: 24" (61.0 cm)

Back: 5" (30.5 cm)

Water Cooled clearance:

Top/Sides: 8" (20.3 cm)

Back: 5" (12.7 cm)

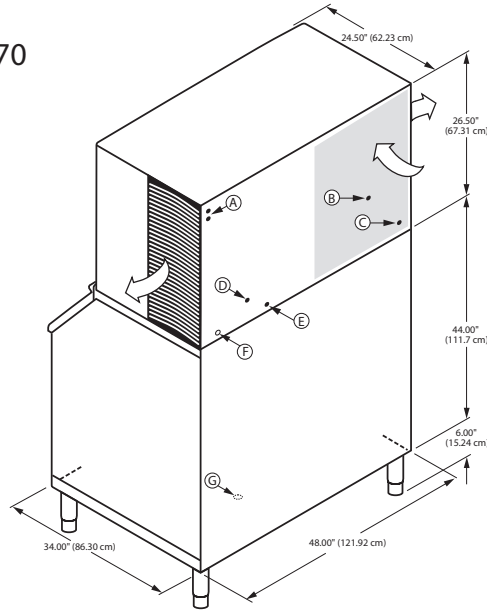

- Ⓐ Electrical Entrance (2) Options
- Ⓑ 1/2" (1.27 cm) F.P.T. Water Condenser Outlet (water-cooled units)
- Ⓒ 3/8" (0.95 cm) F.P.T. Water Condenser Inlet (water-cooled units)
- Ⓓ 3/8" (0.95 cm) F.P.T. Ice Making Water Inlet
- Ⓔ 1/2" (1.27 cm) F.P.T. Ice Making Water Drain
- Ⓕ 1/2" (1.27 cm) Auxillary Base Drain Socket
- Ⓖ 3/4" (1.91 cm) Bin Drain
- Ⓗ Air flow for air-cooled models

Space-Saving Designs



i-1400 B-970

Height	76.50" 194.31 cm
Width	48.00" 121.92 cm
Depth	34.00" 86.30 cm
Bin Storage	710 lbs. 322.2 kgs.

Height includes adjustable bin legs 6.00" to 8.00", (15.24 to 20.32 cm) set at 6.00" (15.24 cm).

Specifications

	Model	Ice Shape	Ice Production 24 Hours		Power Usage kWh/100 lbs. @90° Air/70°F		Water Usage/ 100 lbs. 45.4 kgs. of Ice	ENERGY STAR®
			70° Air/ 50°F Water	90° Air/ 70°F Water	1 Ph	3 Ph	Potable Water	
AIR-COOLED	ID-1402A	dice	1,500 lbs.	1,155 lbs.	4.86	4.86	23.5 gal.	
			682 kgs.	525 kgs.			89 L.	
	IY-1404A	half-dice	1,550 lbs.	1,180 lbs.	4.88	4.88	23.5 gal.	
			705 kgs.	536 kgs.			89 L.	
WATER-COOLED	ID-1403W	dice	1,515 lbs.	1,275 lbs.	3.85	3.85	23.5 gal.	NA
			689 kgs.	580 kgs.			89 L.	
	IY-1405W	half-dice	1,565 lbs.	1,290 lbs.	3.86	3.86	23.5 gal.	NA
			711 kgs.	586 kgs.			89 L.	
* Water-cooled Condenser Water Usage / 100 lbs. / 45.4 kgs. Of Ice: 154 gal. / 583 L. * Water-cooled models are excluded from ENERGY STAR qualification.								
REMOTE-COOLED	ID-1492N	dice	1,430 lbs.	1,220 lbs.	4.52	4.52	23.5 gal.	
			650 kgs.	555 kgs.			89 L.	
	IY-1494N	half-dice	1,480 lbs.	1,230 lbs.	4.53	4.53	23.5 gal.	
			673 kgs.	559 kgs.			89 L.	

Order ice storage bin separately. To order 3 phase add "3" suffix to model # (ID-1202A3).

Accessories

LuminIce™ Growth Inhibitor
reduces yeast and bacteria growth for a cleaner ice machine.



Bin Level Control
Allows ice bin level to be automatically set. Built-in LED light illuminates bin.



Arctic Pure® Water Filters
Reduces sediment and chlorine odors for better tasting ice.



AuCS®
schedules and performs routine ice machine cleaning automatically.

