



**John
BOOS**
Since 1887

ITEM #: _____ QTY: _____
 MODEL #: _____
 PROJECT NAME: _____

071917

3601 S. Banker St. Effingham, IL 62401 • P.O. BOX 609 • Ph: (888) 431-2667 • Fax: (800) 433-2667

"ST6R5-SBK" STAINLESS STEEL TOP WORK TABLES

16GA TOP W/ 5" RISER AND STAINLESS STEEL LEGS AND ADJUSTABLE BRACING

FEATURES:

- 16 GAUGE STAINLESS STEEL TOP W/ 5" RISER & TURNDOWN
- TYPE 300 STAINLESS STEEL WITH # 4 POLISH, SATIN FINISH
- TOP IS SOUND DEADENED
- REINFORCED WITH 1"X2" CHANNEL RUNNING ENTIRE LENGTH OF TABLE
- 1-1/2" STALLION EDGE ON FRONT SIDE EDGES
- 90 DEGREE BEND DOWN FOR TABLE LINE-UP
- STAINLESS STEEL BASE WITH ADJUSTABLE BRACING
- ADJUSTABLE BULLET FEET
- SHIPPED KNOCKED-DOWN, EASY-TO-ASSEMBLE
- NSF AND CSA CERTIFIED



ST6R5-3048SBK

CONSTRUCTION:

- TOP: STAINLESS STEEL TOPS ARE TIG WELDED, EXPOSED WELDS ARE POLISHED TO MATCH ADJACENT SURFACE.

MATERIAL:

- TOP: 16 GAUGE STAINLESS STEEL TYPE 300 STAINLESS STEEL WITH # 4 POLISH, SATIN FINISH
- BRACING: 1-1/4" ROUND O.D. 18 GAUGE STAINLESS STEEL
- LEGS: 1-5/8" ROUND O.D. 16 GAUGE TUBULAR STAINLESS STEEL
- GUSSETS: STAINLESS STEEL
- FEET: 1" ADJUSTABLE STAINLESS BULLET FEET



ADJUSTABLE BRACING

16 GAUGE TOP W/ ADJUSTABLE SHELF

24" WIDE	QTY	30" WIDE	QTY	36" WIDE	QTY
ST6R5-2424SBK		ST6R5-3024SBK		ST6R5-3624SBK	
ST6R5-2430SBK		ST6R5-3030SBK		ST6R5-3630SBK	
ST6R5-2436SBK		ST6R5-3036SBK		ST6R5-3636SBK	
ST6R5-2448SBK		ST6R5-3048SBK		ST6R5-3648SBK	
ST6R5-2460SBK		ST6R5-3060SBK		ST6R5-3660SBK	
ST6R5-2472SBK		ST6R5-3072SBK		ST6R5-3672SBK	
ST6R5-2484SBK		ST6R5-3084SBK		ST6R5-3684SBK	
ST6R5-2496SBK		ST6R5-3096SBK		ST6R5-3696SBK	
ST6R5-24108SBK		ST6R5-30108SBK		ST6R5-36108SBK	
ST6R5-24120SBK		ST6R5-30120SBK		ST6R5-36120SBK	
ST6R5-24132SBK		ST6R5-30132SBK		ST6R5-36132SBK	
ST6R5-24144SBK		ST6R5-30144SBK		ST6R5-36144SBK	

OPTIONAL ACCESSORIES

DESCRIPTION	MODEL #	QTY
DRAWER		
DRAWER LOCK		
CASTERS		
OVERSHELVES		
SINKS		
POT RACK		

DETAILED SPECIFICATIONS

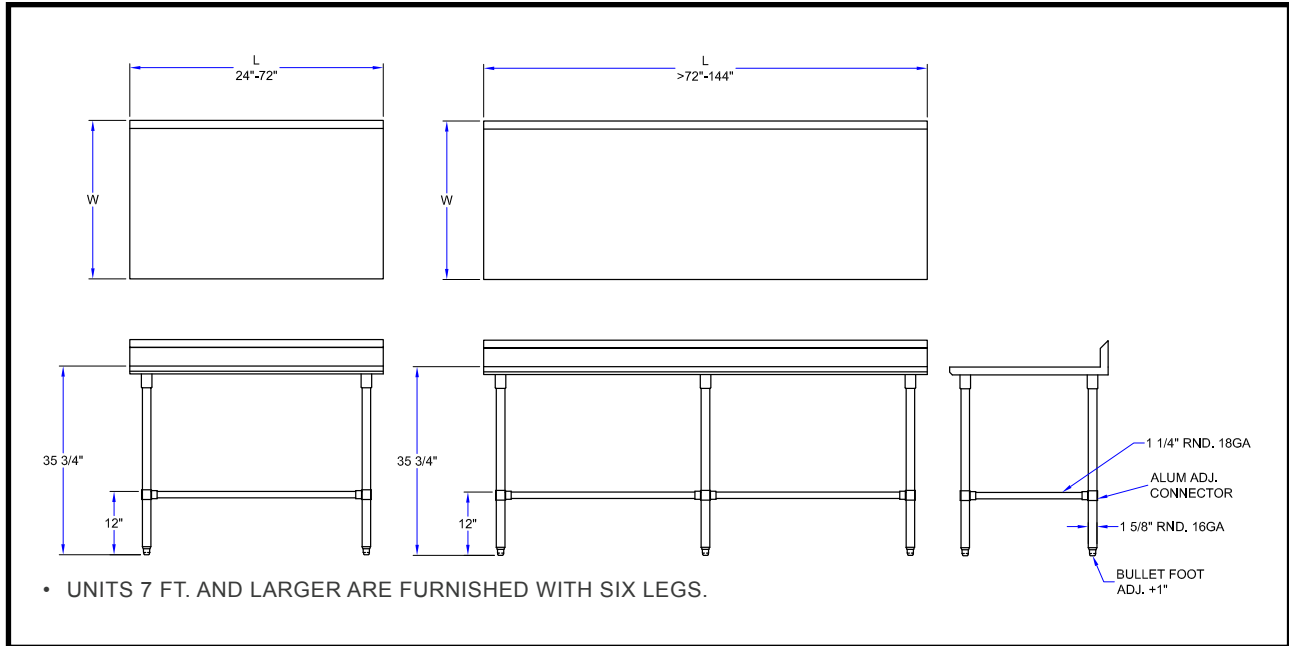

16 GAUGE TOP W/ ADJUSTABLE UNDERSHELF

LENGTH	24" WIDE	WT. (LBS)	30" WIDE	WT. (LBS)	36" WIDE	WT. (LBS)
24"	ST6R5-2424SBK	40	ST6R5-3024SBK	44	ST6R5-3624SBK	50
30"	ST6R5-2430SBK	44	ST6R5-3030SBK	48	ST6R5-3630SBK	56
36"	ST6R5-2436SBK	49	ST6R5-3036SBK	54	ST6R5-3636SBK	61
48"	ST6R5-2448SBK	58	ST6R5-3048SBK	65	ST6R5-3648SBK	73
60"	ST6R5-2460SBK	68	ST6R5-3060SBK	75	ST6R5-3660SBK	84
72"	ST6R5-2472SBK	77	ST6R5-3072SBK	85	ST6R5-3672SBK	96
84"	ST6R5-2484SBK	94	ST6R5-3084SBK	105	ST6R5-3684SBK	121
96"	ST6R5-2496SBK	103	ST6R5-3096SBK	116	ST6R5-3696SBK	133
108"	ST6R5-24108SBK	112	ST6R5-30108SBK	125	ST6R5-36108SBK	142
120"	ST6R5-24120SBK	122	ST6R5-30120SBK	136	ST6R5-36120SBK	154
132"	ST6R5-24132SBK	131	ST6R5-30132SBK	146	ST6R5-36132SBK	165
144"	ST6R5-24144SBK	141	ST6R5-30144SBK	158	ST6R5-36144SBK	179

MODEL # STRUCTURE

24 = WIDTH OF WORK SURFACE
 5 = HT. OF RISER W/ TURNDOWN
 R = RISER TOP WORK TABLE
 6 = 16GA WORK SURFACE
 ST = STAINLESS STEEL TOP

30 = LENGTH OF WORK SURFACE
 SB = STAINLESS LEGS & BRACING
 K = K.D. W/ ADJUSTABLE BRACING

ST6R5-2430SBK

SOME UNITS SHIP UNASSEMBLED FOR REDUCED SHIPPING COST. ALL DIMENSIONS ARE TYPICAL. TOLERANCE +/- .500"
 John Boos & Co. is constantly engaged in a program of improving products and therefore reserves the right to change specifications without prior notice.



3601 S. Banker St. • Effingham, IL 62401 • PO BOX 609 • quotes@johnboos.com

103018



www.johnboos.com

217