



CRI-2-3B-HS(-L)

Commercial Series Refrigerators

CRI-2-3B-HS(-L)

8/12

Item # 13276



Hoshizaki America, Inc. reserves the right to change specifications without notice.

Item #

Project:

Qty:

*AutoCad available on KCL

CRB-HS Dimensions W x D x H

1 Section - 27.5" x 33.6" x 79.63"*

2 Section - 55" x 33.6" x 79.63"*

3 Section - 83" x 33.6" x 79.63"*

*with 4" casters

Electrical/Refrigeration

Voltage 115/60/1

HACR Breaker

1 & 2 Section - 15.0

3 Section - 20.0

Electrical Connection (NEMA)

1 & 2 Section - 5-15P

3 Section - 5-20P

Voltage Range 104-126

Ambient Temp. Range 45°-100°F

Control Setpoint Range 34° to 52°F

*Refrigerant R-134a

Warranty

Valid in United States, Canada, Puerto Rico, and U.S. Territories. Contact factory for warranty in other countries.

• **Two Year** - Parts & Labor on entire machine.

• **Five Year** - Parts on: Compressor.

Options

• Door reversal kit

• Additional epoxy shelves

• Stainless steel shelves

• Combination universal tray/pan slides

• Air filter



- Stainless steel exterior front and sides
- Energy efficient, vacuum formed, seamless, one piece ABS interior liner
- Refrigerant flow is controlled with a TXV expansion valve
- Unique "ducted" air distribution system
- Solid state digital controller with temperature alarms and LED display (Fahrenheit or Celsius)
- Cabinet and doors are insulated with 2-3/8" of R-134a, CFC free, foamed in place polyurethane
- Doors are constructed of stainless steel exterior, an ABS interior liner and are standard with locks
- Exclusive "stepped" door design to protect recessed door gasket
- Spring assisted self closing doors with stay open feature
- Sturdy 8 gauge stainless steel hinge plate with welded hinge pin
- One piece, full length, extruded aluminum flush mount door handle
- Field reversible doors (with optional kit)
- Enamel coated evaporator coil
- Automatic hot gas condensate evaporator
- Stainless steel shelf supports
- (3) Epoxy coated wire shelves per section adjustable 1" on center
- Standard with 4" factory installed casters (two with brakes)
- Stackable (two units high) to conserve warehouse floor space
- Two years parts and labor warranty
- Five year compressor warranty
- 8 ft. cord and plug

* CR1B-HS and CR2B-HS are ENERGY STAR qualified

Dimensions / Capacity

Model #	One Section CR1B-HS(-L)	Two Section CR2B-HS	Three Section CR3B-HS	
Nominal Storage Capacity (CF)	23.3 ft ³	51.0 ft ³	74.3 ft ³	
Interior Storage Capacity (CF) (AHAM)	20.8 ft ³	47.0 ft ³	67.9 ft ³	
Overall Width x Depth	27.5" x 33.6"	55" x 33.6"	83" x 33.6"	
Height (including 4" casters)	79.63"	79.63"	79.63"	
Door Opening Width x Height	22.8" x 28.1"	22.8" x 28.1"	22.8" x 28.1"	
Depth with Door open at 90°	59.6"	59.6"	59.6"	
Adjustable Shelves	3	6	6 (Left)	3 (Right)
Shelf Dimensions (W x D)	21.25" x 26"	23.9" x 24.6"	23.9" x 24.6"	21.25" x 26"
Crated Shipping Weight	345 lbs	550 lbs	880 lbs	
Crated Height x Width x Depth	83" x 31.5" x 39.5"	83" x 59" x 39.5"	83" x 90.5" x 39.5"	

Electrical & Refrigeration Data

Model #	One Section CR1B-HS(-L)	Two Section CR2B-HS	Three Section CR3B-HS	
Amperage	3.7	7.0	12.0	
Energy Consumption (kwh/day) ENERGY STAR	2.28	3.52	5.80	
Heat Rejection (BTU/Hr.) @ NSF	450	866	866 (Left)	450 (Right)
Approx. Nominal Compres. BTU/HR(HP)	1625(.2HP)	2373(.25+HP)	2373(.25+HP)	1625(.2HP)



© HOSHIZAKI AMERICA, INC.

618 Hwy. 74 S., Peachtree City, GA 30269

TEL 800-438-6087

FAX 800-345-1325

www.hoshizaki.com



CRI-2-3B-HS(-L)

Commercial Series Refrigerators

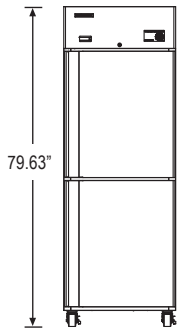

CR1B-HS

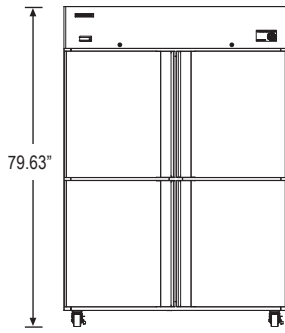

CR2B-HS

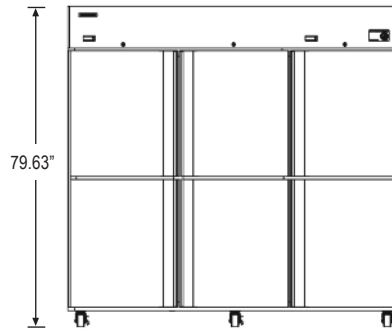

CR3B-HS

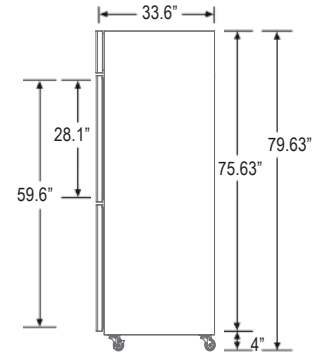

SIDE VIEW

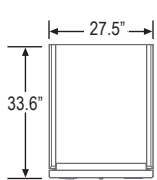

PLAN VIEW

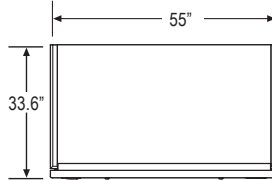

PLAN VIEW

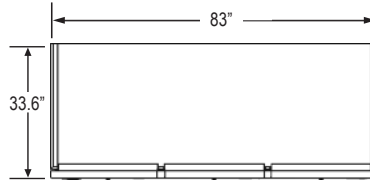

PLAN VIEW

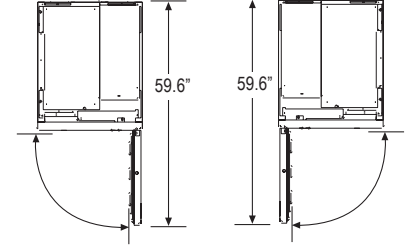

SWING
CR1B-HS

SWING
CR1B-HSL

Cabinet Construction

The exterior cabinet front, front panel, and sides, are constructed of high quality stainless steel. The exterior top, back and bottom are made from galvanized steel. The cabinet interior is constructed of a gray energy efficient, vacuum formed, seamless, one piece ABS liner. A unique "ducted" air flow system assures even temperature distribution throughout the cabinet. Three (3) heavy duty epoxy coated shelves per section are standard. Mounted on stainless steel pilasters, the shelves are adjustable in 1" increments. Cabinet walls and doors are insulated with 2-3/8" of environmentally friendly R-134A, CFC free, foamed in place polyurethane. Side walls are fully foamed for additional structure at the top of the cabinet. An interior light is automatically activated when doors are opened. 4" factory installed polyolefin, plated casters (two with brakes) are standard.

Door Construction

Doors are constructed of high grade stainless steel exterior, an ABS interior liner and are standard with locks. Hoshizaki's exclusive "stepped" design protects the recessed gasket while product is being removed from the cabinet. Doors are provided with a one piece, full length, extruded aluminum, flush mount handle and are mounted on eight (8) gauge stainless steel hinge plates with a welded hinge pin. Spring assisted self closing doors are equipped with a stay open feature past 90 degrees. Snap-in magnetic door gaskets are durable and easily removed for cleaning. Door hinging is field reversible (with an optional door reversal hinge kit).

Refrigeration System

The high efficiency, self contained refrigeration system is top mounted and easily accessible for service. The refrigeration system components are assembled on a high density expanded polypropylene platform that is removable from the main unit. A unique, ducted air flow system achieves uniform air distribution within the cabinet. The evaporator coil is enamel coated for extended life. Energy efficient, automatic hot gas condensate evaporator removes condensation. A thermostatic expansion valve system controls the flow of environmentally friendly R-134A refrigerant through the evaporator. Solid state, digital controls monitor the operation and performance of the refrigeration system. The controls also provide visual high and low temperature and high and low voltage alarms. The controller has a digital LED display and is adjustable to either Fahrenheit or Celsius. 115 volt units are equipped with an eight foot cord and plug (20.0 amps or less).

