

# F-1001M\_H

## MODULAR FLAKER ICE MACHINE

### SLIM-LINE SERIES

Item # \_\_\_\_\_

Project: \_\_\_\_\_

Qty: \_\_\_\_\_

\*AutoCad available on KCL

F-1001M\_H

3/06

Item # 13108

#### FLAKER DIMENSIONS

W x D x H

**F-1001M\_H**

22 x 27<sup>3/8</sup> x 25<sup>15/16</sup>

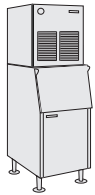

B-300



B-500

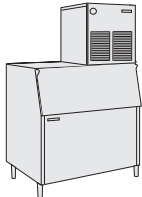

B-700

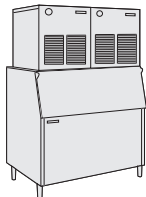

B-800

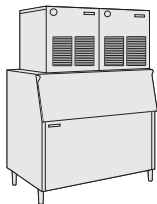

B-900

Also available on Large Bins:

B-1150SS

B-1300SS

B-1500SS

B-1650SS



#### F-1001MAH

Air-Cooled

Shown on an optional  
B-700

#### F-1001MWH

Water-Cooled

#### F-1001MRH

Remote Air-Cooled

- Up to 970 lbs. of ice production per 24 hours
- Durable stainless steel exterior
- CleanCycle I2® Design 
- 15 minute flush cycle every 12 hours
- Removes sediment
- Cleaner ice
- Longer life and easy maintenance
- R-404A Refrigerant



#### Warranty

Valid in United States, Canada, Puerto Rico, & U.S. Territories. Contact factory for warranty in other countries.

**Two Year** - Parts & Labor on entire machine.

**Five Year** - Parts on compressor, air-cooled condenser coil.



# Hoshizaki

## F-100IM\_H FLAKER ICE MACHINE SLIM-LINE MODULAR SERIES

**DIMENSIONS**  
W x D x H  
**F-100IM H**  
22 x 27<sup>3/8</sup> x 25<sup>15/16</sup>

- Air-cooled
- Water-cooled
- Remote Air-cooled

### AIR-COOLED

Water Temp ° F.	50°	70°	90°
Air Temp ° F.			
70°	970	930	890
80°	855	820	785
90°	755	<b>740</b>	695

### WATER-COOLED

Water Temp ° F.	50°	70°	90°
Air Temp ° F.			
70°	890	855	840
80°	820	805	785
90°	770	<b>755</b>	735

### REMOTE AIR-COOLED

Water Temp ° F.	50°	70°	90°
Air Temp ° F.			
70°	930	895	865
80°	835	805	780
90°	750	<b>745</b>	700

### UTILITY CONSUMPTION

Model Number	Approximate Electrical		KWH per 100 LBS.		Condenser Water Gal. per 100 lbs.	
	90/70	70/50	90/70	70/50	90/70	70/50
F-1001MAH	1755	1530	5.7	3.8	N/A	N/A
F-1001MWH	1248	1245	4.1	3.1	63	34
F-1001MRH	1520	1570	4.9	4.1	N/A	N/A

### SPECIFICATIONS

Model Number	Condenser	Amperage	Min. Circuit Ampacity	Shipping Weight
F-1001MAH	Air-Cooled	8.1	15	210 lbs.
F-1001MWH	Water-Cooled	7.2	15	210 lbs.
F-1001MRH	Remote Air-Cooled	10.2	15	210 lbs.

### STORAGE BINS

Model Number	Application Capacity	ARI-Rated Capacity
B-300	300 lbs.	260 lbs.
B-500	500 lbs.	360 lbs.
B-700	700 lbs.	550 lbs.
B-800	800 lbs.	600 lbs.
B-900	900 lbs.	660 lbs.
B-1150	1150 lbs.	N/A
B-1300	1275 lbs.	N/A
B-1500	1490 lbs.	N/A
B-1650	1605 lbs.	N/A

### ELECTRICAL & PLUMBING/F-100IM\_H

- 208-230V/60/1 (3 wire with dedicated neutral for 115V)
- 3/8" OD copper or equivalent independent potable water supply
- 3/4" FPT independent drain connection



© HOSHIZAKI AMERICA, INC.

618 Hwy. 74 S., Peachtree City, GA 30269

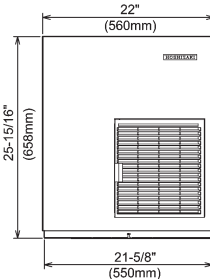

FRONT VIEW

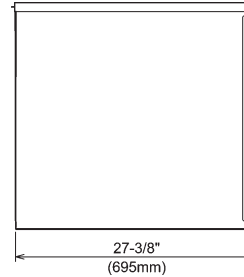

SIDE VIEW

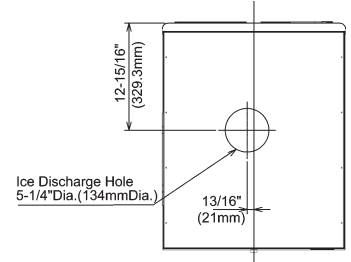

ICE DROP ZONE

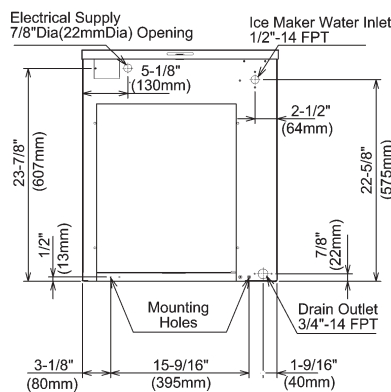

AIR-COOLED UNIT

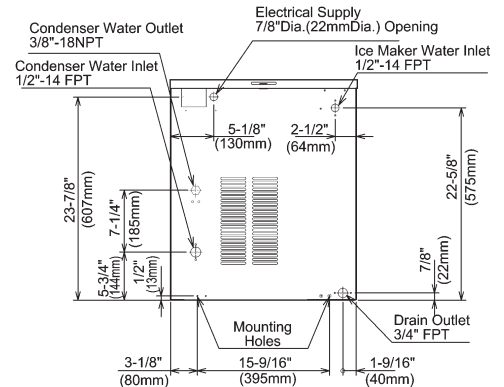

WATER-COOLED UNIT

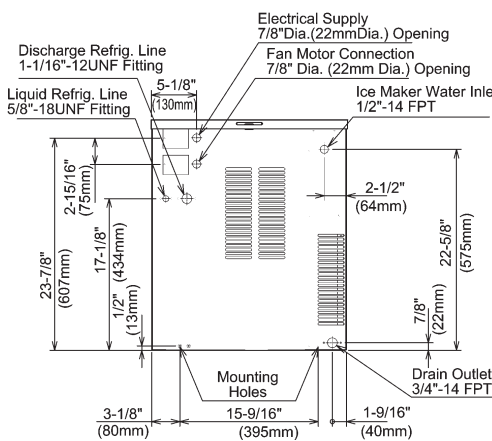

REMOTE AIR-COOLED UNIT

**URC-6F Remote Condenser** (Sold Separately)  
For Use with F-1001MRH

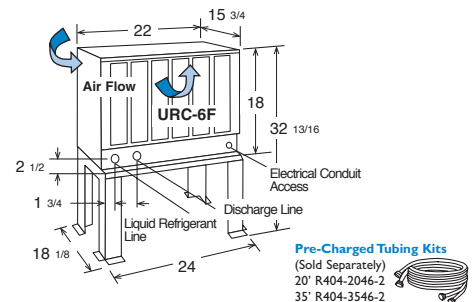

Voltage supply for the URC Remote Condenser is supplied from the Ice Maker. No additional circuit is required.

### OPERATING LIMITS

- Ambient Temp Range 45 - 100°F
- Water Temp Range 45 - 90°F
- Water Pressure 10 - 113psig
- Voltage Range 187 - 253V

### SERVICE

- Panels easily removed and all components accessible for service.
- Removable/cleanable air filter. (Air-Cooled model only)

TEL 1-800-438-6087

FAX 1-800-345-1325

www.hoshizaki.com

Printed in U.S.A.

