

F-1501M_H

MODULAR FLAKER ICE MACHINE

Item # _____

Project: _____

Qty: _____

*AutoCad available on KCL

F-1501M_H

4/22/16

Item #13339

FLAKER DIMENSIONS

W x D x H

F-1501M_H
30 x 27^{1/2} x 34^{7/16}



B-500

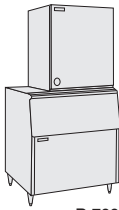

B-700

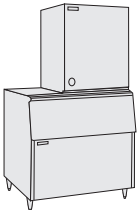

B-800

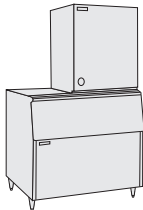

B-900

Also available on Large Bins:

B-1150SS

B-1300SS

B-1500SS

B-1650SS

*FLAKED ICE DIMENSIONS

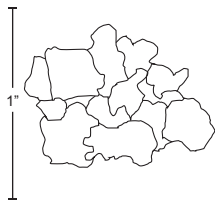

*approximate size, image not to scale



F-1501MAH

Air-Cooled

Shown on an optional
B-900

F-1501MWH

Water-Cooled

F-1501MRH

Remote Air-Cooled

- Up to 1590 lbs. of ice production per 24 hours
- Durable stainless steel exterior
- Advanced CleanCycle24™ Design
- Removes sediment
- Cleaner ice
- Longer life and easy maintenance
- R-404A Refrigerant



* The F-1501MAH and F-1501MRH are ENERGY STAR qualified.

Warranty

Valid in United States, Canada, Puerto Rico, & U.S. Territories. Contact factory for warranty in other countries.

Three Year - Parts & Labor on entire machine. (Serial numbers Vxxxxxj) and after.)

Five Year - Parts on Compressor, air-cooled condenser coil.



ISO 9001-ISO 14001



AHRM CERTIFIED
www.ahrminc.org



NSF



UL CERTIFIED
SAI0203

© HOSHIZAKI AMERICA, INC.

618 Hwy. 74 S., Peachtree City, GA 30269

TEL 1-800-438-6087

FAX 1-800-345-1325

www.hoshizaki.com



HOSHIZAKI

F-150IM_H FLAKER ICE MACHINE MODULAR SERIES

DIMENSIONS
W x D x H
F-150IM H
30 x 27^{1/2} x 34^{7/16}

- Air-cooled
- Water-cooled
- Remote Air-cooled

AIR-COOLED

Water Temp° F.	50°	70°	90°
Air Temp° F.			
70°	1590	1514	1447
80°	1382	1321	1262
90°	1206	1110	1100

WATER-COOLED

Water Temp° F.	50°	70°	90°
Air Temp° F.			
70°	1460	1446	1409
80°	1374	1340	1306
90°	1273	1265	1210

REMOTE AIR-COOLED

Water Temp° F.	50°	70°	90°
Air Temp° F.			
70°	1585	1532	1484
80°	1439	1394	1351
90°	1309	1237	1230

UTILITY CONSUMPTION

Model Number	KWH per 100 LBS. 90/70	Potable Water Gal. per 100 lbs.
F-1501MAH	4.03	12.0
F-1501MWH	3.40	12.0
F-1501MRH	3.85	12.0

SPECIFICATIONS

Model Number	Condenser	Amperage	Min. Circuit Ampacity	Shipping Weight
F-1501MAH	Air-Cooled	15.93	20	325 lbs.
F-1501MWH	Water-Cooled	15.44	20	325 lbs.
F-1501MRH	Remote Air-Cooled	18.44	20	315 lbs.

STORAGE BINS

Model Number	AHRI-Rated Capacity*
B-500	360 lbs.
B-700	550 lbs.
B-800	600 lbs.
B-900	660 lbs.
B-1150	900 lbs.
B-1300	950 lbs.
B-1500	1120 lbs.
B-1650	1210 lbs.

*Rated in accordance with AHRI Standard 820 (I-P)

ELECTRICAL & PLUMBING/F-150IM_H

- 208-230V/60/1 (3 wire with dedicated neutral for 115V)
- Ice maker Water Supply Line: Minimum 1/4" Nominal ID Copper Water Tubing or Equivalent
- Ice maker Drain Line: Minimum 3/4" Nominal ID Hard Pipe or Equivalent



© HOSHIZAKI AMERICA, INC.

618 Hwy. 74 S., Peachtree City, GA 30269

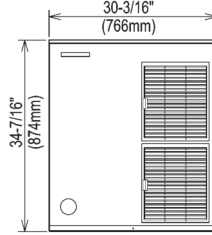

FRONT VIEW

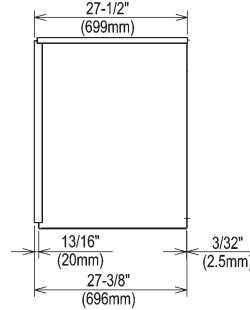

SIDE VIEW

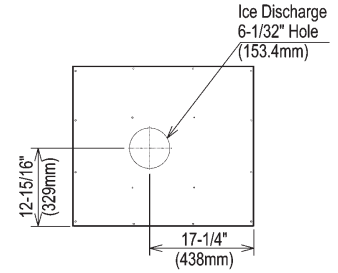

ICE DROP ZONE

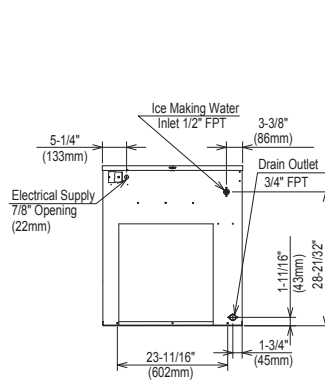

AIR-COOLED UNIT

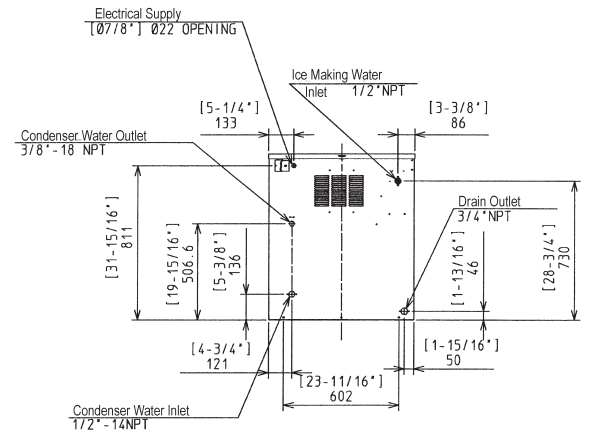

WATER-COOLED UNIT

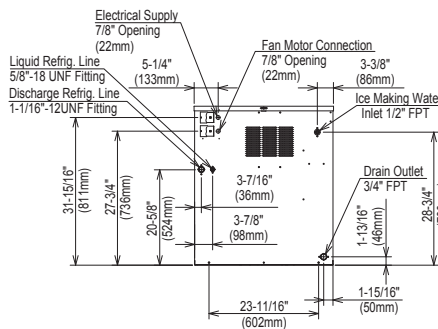

REMOTE AIR-COOLED UNIT

URC-14F Remote Condenser (Sold Separately)
For Use with F-1501MRH-C

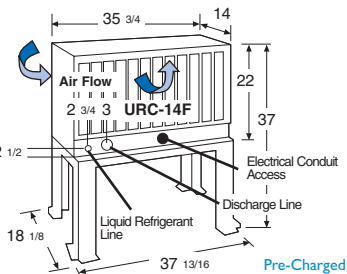

Pre-Charged Tubing Kits

- (Sold Separately)
- 20' R404-2068-2
- 35' R404-3568-2
- 55' R404-5568-2

Voltage supply for the URC Remote Condenser is supplied from the Ice Maker. No additional circuit is required.

OPERATING LIMITS

- Ambient Temp Range 45 - 100°F
- Water Temp Range 45 - 90°F
- Water Pressure 10 - 113psig
- Voltage Range 104 - 127V

SERVICE

- Panels easily removed and all components accessible for service.
- Removable/cleanable air filter. (Air-Cooled models only)

TEL 1-800-438-6087

FAX 1-800-345-1325

www.hoshizaki.com

Printed in U.S.A.

