

F-801M_H

MODULAR FLAKER ICE MACHINE

SLIM-LINE SERIES

Item # _____

Project: _____

Qty: _____
 *AutoCad available on KCL

F-801M_H
 04/22/16
 Item #I3037

FLAKER DIMENSIONS

W x D x H

F-801M_H
 22 x 27^{3/8} x 25^{15/16}



B-300

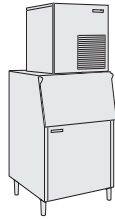

B-500

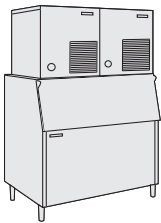

B-700

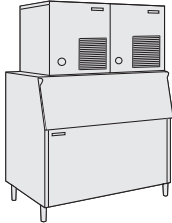

B-800

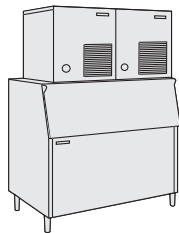

B-900

Also available on Large Bins:
 B-1150SS
 B-1300SS
 B-1500SS
 B-1650SS

*FLAKED ICE DIMENSIONS



*approximate size, image not to scale



F-801MAH

Air-Cooled
 Shown on an optional
 B-500

F-801MWH

Water-Cooled

- Up to 795 lbs. of ice production per 24 hours
- Durable stainless steel exterior
- CleanCycle I2™ Design 
- 15 minute flush cycle every 12 hours
- Removes sediment
- Cleaner ice
- Longer life and easy maintenance
- Removable air filters (Air-cooled model only)
- R-404A refrigerant

* The F-801MAH is ENERGY STAR qualified.

Warranty

Valid in United States, Canada, Puerto Rico, & U.S. Territories. Contact factory for warranty in other countries.

Three Year - Parts & Labor on entire machine. (Serial numbers Vxxxxxj and after.)

Five Year - Parts on Compressor, air-cooled condenser coil.



1K090C11-15CH4901



HOSHIZAKI

F-801M_H FLAKER ICE MACHINE SLIM-LINE SERIES

DIMENSIONS
W x D x H
F-801M H
22 x 27^{3/8} x 25^{15/16}

- Air-cooled
- Water-cooled

AIR-COOLED

Water Temp ° F.	50°	70°	90°
Air Temp ° F.	70°	756	725
	80°	696	640
	90°	614	594

WATER-COOLED

Water Temp ° F.	50°	70°	90°
Air Temp ° F.	70°	665	647
	80°	629	595
	90°	579	584

UTILITY CONSUMPTION

Model Number	Approx. Elec. Watts		KWH per 100 LBS.		Potable Water Gal. per 100 lbs.	Cond. Water Gal. per 100 lbs.	
	90/70	70/50	90/70	70/50		90/70	70/50
F-801MAH	1028	958	4.21	2.90	12.0	N/A	N/A
F-801MWH	979	976	4.10	3.54	12.0	81	39

SPECIFICATIONS

Model Number	Condenser	Amperage	Min. Circuit Ampacity	Shipping Weight
F-801MAH	Air-Cooled	11.4	20	205 lbs.
F-801MWH	Water-Cooled	10.5	20	205 lbs.

STORAGE BINS

Model Number	AHRI-Rated Capacity*
B-300	260 lbs.
B-500	360 lbs.
B-700	550 lbs.
B-800	600 lbs.
B-900	660 lbs.
B-1150	900 lbs.
B-1300	950 lbs.
B-1500	1120 lbs.
B-1650	1210 lbs.

*Rated in accordance with AHRI Standard 820 (I-P)

ELECTRICAL & PLUMBING/F-801M_H

- 115-120V/60/1
- 20 amp Max Fuse/HACR Breaker Size
- Ice maker Water Supply Line: Minimum 1/4" Nominal ID Copper Water Tubing or Equivalent
- Ice maker Drain Line: Minimum 3/4" Nominal ID Hard Pipe or Equivalent
- Water-Cooled Model (Lines Must be Independent of Ice maker)
- Condenser Water Supply Line: Minimum 1/4" Nominal ID Copper Water Tubing or Equivalent
- Condenser Drain/Return Line: Minimum 1/4" Nominal ID Hard Pipe (open drain system) or Copper Water Tubing (closed loop system) or Equivalent



© HOSHIZAKI AMERICA, INC.

618 Hwy. 74 S., Peachtree City, GA 30269

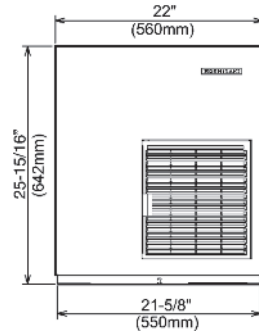

FRONT VIEW

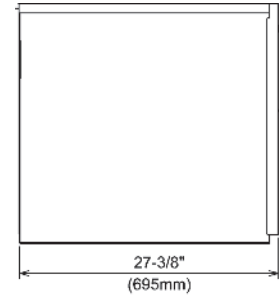

SIDE VIEW

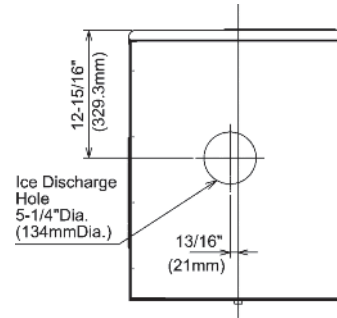

ICE DROP ZONE

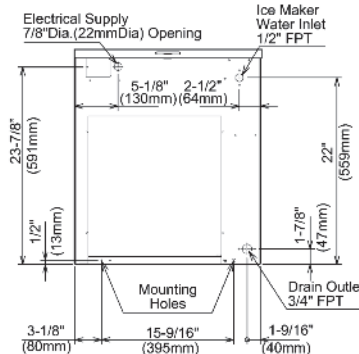

AIR-COOLED UNIT

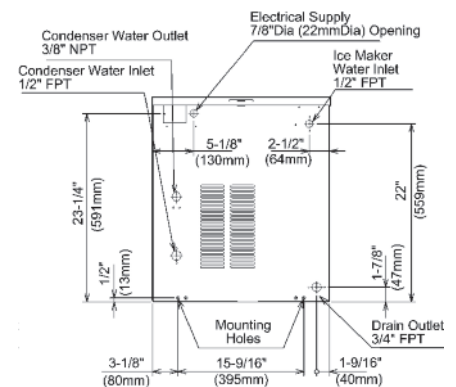

WATER-COOLED UNIT

OPERATING LIMITS

- Ambient Temp Range 45 - 100°F
- Water Temp Range 45 - 90°F
- Water Pressure 10 - 113psig
- Voltage Range 104 - 127V

SERVICE

- Panels easily removed and all components accessible for service.
- Removable/cleanable air filter (Air-Cooled model only)



TEL 1-800-438-6087

FAX 1-800-345-1325

www.hoshizaki.com

Printed in U.S.A.