

# KM-1400S\_H-M(3)

## STACKABLE ICE CUBER

### MARINE SERIES

Item # \_\_\_\_\_

Project: \_\_\_\_\_

Qty: \_\_\_\_\_

\*AutoCad available on KCL

KM-I400S\_H-M(3)

9/10

Item # 13267

**KM-I400S\_H-M(3)**  
48 x 27<sup>3/8</sup> x 27<sup>3/8</sup>

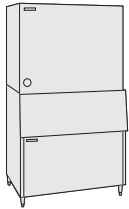

B-800

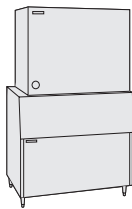

B-900

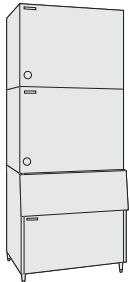

B-800

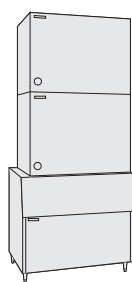

B-900

### KM-I400SWH-M



Water-Cooled 1 Phase  
Shown on an optional  
B-900

### KM-I400SWH3-M

Water-Cooled 3 Phase



Also available on Large Bins:  
B-1150SS  
B-1300SS  
B-1500SS  
B-1650SS

- Up to 1370 lbs. of ice production per 24 hours
- Durable stainless steel exterior and interior
- Stainless steel evaporator
- Individual crescent cube
- Protected by *HoshiGuard* Antimicrobial Agent 
- CycleSaver® design 
- EverCheck® alert system 
- Stackable for 2740 lbs. per 24 hour ice production in the same floor space
- Electrical: 208-230/60/1 (2 wire)
- Cupro-nickel water-cooled condenser for corrosive water conditions
- R-404A Refrigerant



### Warranty

Valid in United States, Canada, Puerto Rico, & U.S. Territories. Contact factory for warranty in other countries.

**Three Year** - Parts & Labor on entire machine.

**Five Year** - Parts & Labor on: Evaporator.

**Five Year** - Parts on: Compressor, air-cooled condenser coil.



# Hoshizaki

## KM-I400S\_H-M(3) STACKABLE ICE CUBER

### DIMENSIONS

W x D x H

**KM-I400S\_H-M(3)**

48 x 27<sup>3/8</sup> x 27<sup>3/8</sup>

### STACKABLE ICE CUBER

- Water-cooled 1 phase / Water-cooled 3 phase

#### WATER - COOLED 1 PHASE

Water Temp ° F.	50°	70°	90°
Air Temp ° F.			
70°	1370	1347	1252
80°	1353	1318	1186
90°	1347	<b>1293</b>	1175

#### WATER - COOLED 3 PHASE

Water Temp ° F.	50°	70°	90°
Air Temp ° F.			
70°	1343	1317	1211
80°	1323	1283	1138
90°	1317	<b>1255</b>	1124

#### UTILITY CONSUMPTION

Model Number	Ice Production Per Cycle		KWH per 100 LBS.	Potable Water Gal. per 100 lbs.	Condenser Water Gal. per 100 lbs.
	Lbs.	Cubes			
KM-1400SWH-M	32.5	1440	3.4	18.9	161
KM-1400SWH3-M	31.9	1440	3.3	17.9	146

#### SPECIFICATIONS

Model Number	Condenser	Amperage	Min. Circuit Ampacity	Shipping Weight
KM-1400SWH-M	Water-Cooled	9.7	15	315 lbs.
KM-1400SWH3-M	Water-Cooled	7.1	15	315 lbs.

#### STORAGE BINS

Model Number	Application Capacity	ARI-Rated Capacity
B-800	800 lbs.	600 lbs.
B-900	900 lbs.	660 lbs.
B-1150	1150 lbs.	N/A
B-1300	1275 lbs.	N/A
B-1500	1490 lbs.	N/A
B-1650	1605 lbs.	N/A

#### ELECTRICAL & PLUMBING/KM-I400S\_H-M(3)

- KM-I400SWH-M
- 208 - 230V/60/1ø (2 wire)
- KM-I400SWH3-M
- 208 - 230V/60/3ø
- KM-I400SWH-M & KM-I400SWH3-M
- 15 amp Max Fuse/HACR Breaker Size
- 1/2" OD copper or equivalent independent potable water supply
- 3/4" FPT independent drain connection

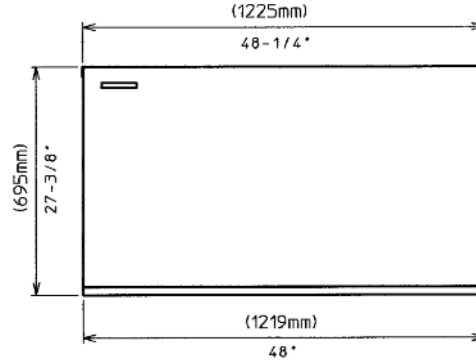

FRONT VIEW

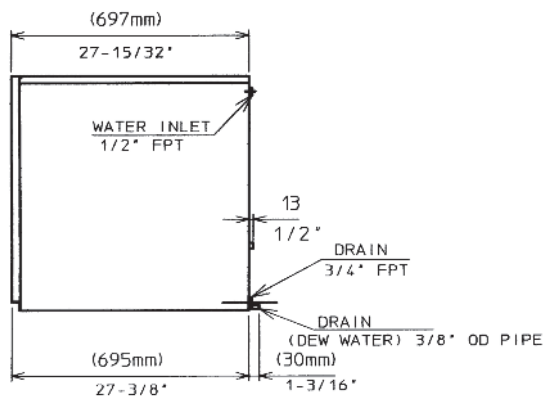

SIDE VIEW

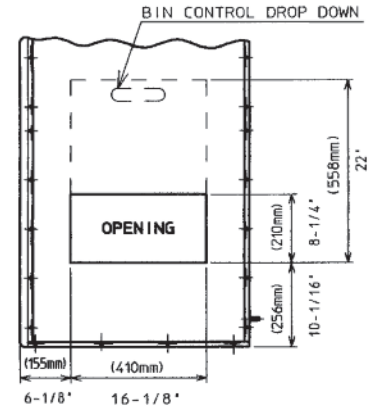

ICE DROP ZONE

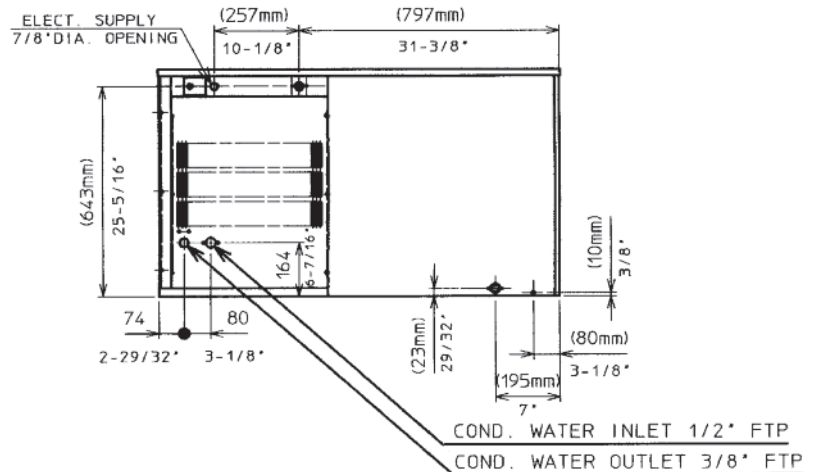

BACK VIEW

#### OPERATING LIMITS

- Ambient Temp Range 45 - 100°F
- Water Temp Range 45 - 90°F
- Water Pressure 10 - 113psig
- Voltage Range 187 - 253V

#### SERVICE

- Panels easily removed and all components accessible for service.



© HOSHIZAKI AMERICA, INC.

618 Hwy. 74 S., Peachtree City, GA 30269

TEL 1-800-438-6087 FAX 1-800-345-1325  
KaTom Restaurant Supply, Inc.

www.hoshizaki.com

Printed in U.S.A.

