

KMS-750MLH

SERENITY SERIES

CUBER ICE MACHINE

Item # _____

Project: _____

Qty: _____

KMS-750MLH

1/08

Item # 13203

CUBER DIMENSIONS

W x D x H

KMS-750MLH
30 x 24 x 28

CONDENSING UNIT DIMENSIONS



W x D x H

Installation Dimension*
SRK-7H
52^{3/8} x 19^{1/2} x 43
*Dimensions include legs

Actual Dimension
SRK-7H
50 x 17 x 28



KMS-750MLH
Remote Air-Cooled
Shown on an optional
Lancer 30" Dispenser

- Up to 770 lbs. of ice production per 24 hours
- Less heat in the kitchen
- Minimized noise
- Durable stainless steel exterior
- Individual crescent cube ice
- Protected by *HoshiGuard* Antimicrobial Agent **HOSHIGUARD**
- CycleSaver® Design 
- EverCheck® alert system 
- Stainless steel evaporator
- Removable water tank - cleaning access to dispenser
- R-404A Refrigerant
- Complies with California Energy Commission guidelines (CEC)

* The KMS-750MLH is ENERGY STAR certified.

Warranty

Valid in United States, Canada, Puerto Rico, & U.S. Territories. Contact factory for warranty in other countries.

Three Year - Parts & Labor on entire machine.

Five Year - Parts & Labor on: Evaporator.

Five Year - Parts on: Compressor, air-cooled condenser coil.



© HOSHIZAKI AMERICA, INC.

618 Hwy. 74 S., Peachtree City, GA 30269

TEL 1-800-438-6087

FAX 1-800-345-1325

www.hoshizaki.com



HOSHIZAKI

KMS-750MLH CUBER ICE MACHINE SERENITY SERIES

DIMENSIONS
W x D x H
KMS-750MLH
30 x 24 x 28

**Installation Dimension*
SRK-7H**
52^{3/8} x 19^{1/2} x 43
*Dimensions include legs
**Actual Dimension
SRK-7H**
50 x 17 x 28

REMOTE AIR - COOLED

Water Temp ° F.	50°	70°	90°
Air Temp ° F.			
70°	770	749	691
80°	754	722	647
90°	749	700	630

UTILITY CONSUMPTION

Model Number	Ice Production Per Cycle Lbs. Cubes	KWH per 100 LBS. 90/70	Potable Water Gal. per 100 lbs.	Condenser Water Gal. per 100 lbs.
KMS-750MLH with SRK-7H	15 832	5.6	15.6	N/A

SPECIFICATIONS

Model Number	Condenser	Amperage	Min. Circuit Ampacity	Shipping Weight
KMS-750MLH	Remote Air-Cooled	13	20	163 lbs.
SRK-7H	Air-Cooled			240 lbs.

ELECTRICAL & PLUMBING/KMS-750MLH

- 115V/60/1 - Voltage supply for the KMS Ice Maker is supplied from the SRK Remote Condenser
- 1/2" FPT copper or equivalent independent potable water supply
- 3/4" FPT independent drain connection

CONDENSER UNIT/SRK-7H

- 208-230/60/1 (3 wire with neutral for 115V)
- 20 amp Max Fuse/HACR Breaker Size



© HOSHIZAKI AMERICA, INC.

618 Hwy. 74 S., Peachtree City, GA 30269

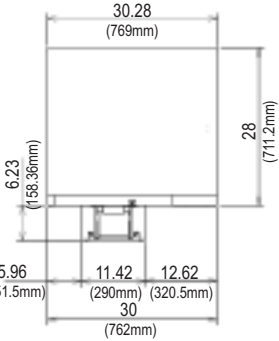

FRONT VIEW

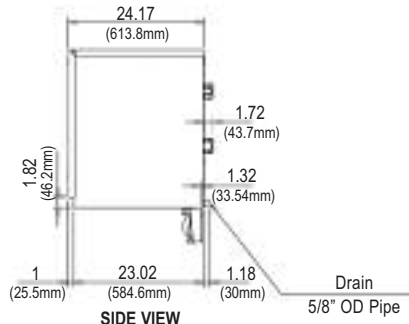

SIDE VIEW

SRK-7H Remote Condensing Unit (Sold Separately)
For Use with KMS-750MLH

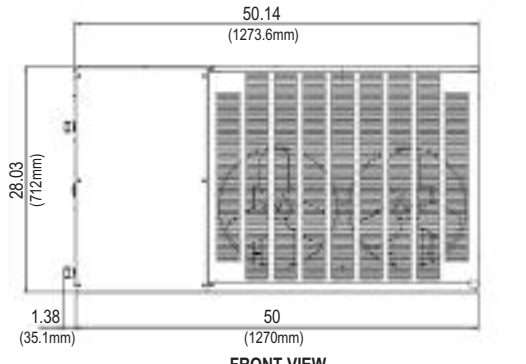

FRONT VIEW

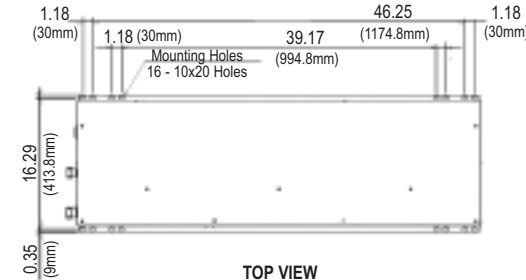

TOP VIEW

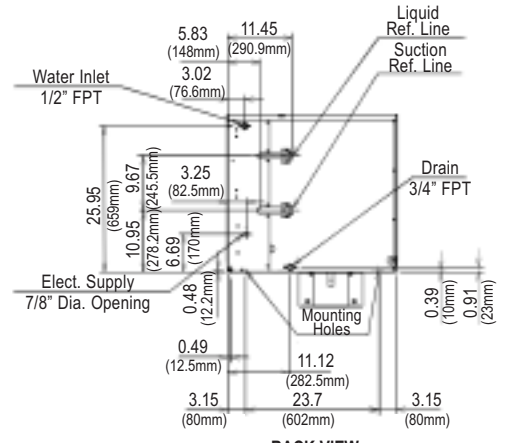

BACK VIEW

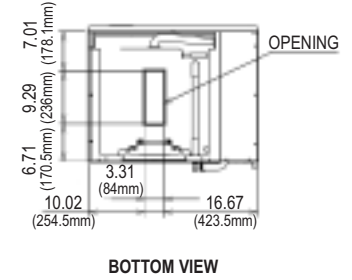

BOTTOM VIEW

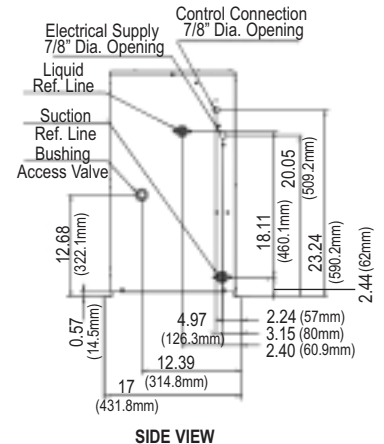

SIDE VIEW

Pre-Charged Tubing Kits

- (Sold Separately)
- 20' R404-20810
- 35' R404-35810
- 55' R404-55810



Voltage supply for the KMS Ice Maker is supplied from the SRK Remote Condenser.

OPERATING LIMITS

- Ambient Temp Range 45 - 100°F
- Water Temp Range 45 - 90°F
- Water Pressure 10 - 113psig
- Voltage Range 104 - 127V

CONDENSING UNIT

- Voltage Range 187 - 253V
- Ambient Temp Range -20 - 122° F

SERVICE

- Panels easily removed and all components accessible for service.

TEL 1-800-438-6087

FAX 1-800-345-1325

www.hoshizaki.com

Printed in U.S.A.

