



Induction Baby Hob 3.5kW

Item: GI-BH/BA 2500

Quantity: _____

Project: _____

Approval: _____

Date: _____

Induction Baby Hob 3.5kW

Models:

GI-BH/BA 3500



How Induction Works:

Although induction seems magical in how it works, there is a scientific explanation.

1. An alternating current in an induction coil produces an alternating magnetic field
2. This magnetic field is instantly transferred and concentrated to the cooking vessel
3. This concentrated magnetic energy in the cooking vessel causes it to heat up and start cooking
4. When the vessel is removed from the heat source, the induction unit automatically shuts off

Standard Features:

- Compact table top design with stainless steel body and high impact ceramic glass top
- Sloped, easy to see front panel with adjustable control for easy operation
- Dial control knob with 9 power level settings.
- Integral cooling fan keeps electronics cool, discharging from rear with protective air deflectors preventing hot exhaust to be pulled back into unit
- Removable, reusable easy to clean air intake filter
- 6' (1829mm) cord and plug supplied (60 cycle units only)
- "Flat Design", compact high performance electronics allow for low unit heights
- Instant energy transmission to the pan
- Thermostatically controlled overheat sensor shuts the unit off to prevent damage from pans cooking dry
- Induction technology transfers heat to the pan, not to the surrounding air, allowing for cool operation
- Innovated new technology for pan detection; RTCS is an internal control software development matching speed, capability and performance
 - R – Real Time
 - T – Temperature
 - C – Control
 - S – System
- Electronic output limitation continually monitors the energy transfer to the pan, helping to ensure the most efficient energy transfer possible

Specifications:

Shall be a Garland Induction Unit GI-BH/BA 3500 with a total kW rating of 3.5 kW. Built with a robust stainless steel casting with ceran ceramic glass work top. Compact powerful electronic system for years of reliable service. Overheat sensors to help prevent damage to unit if pan is run dry. Easy to operate system with rotary switch. Unit to come in 208V or 240V power (specify at the time of order) with integral cord and plug.

Note: Induction cooking requires magnetic pots and pans to work effectively.





Conforms to UL-197 & NSF-4
 Certified to CAN/CSA
 C22.2 NO. 109 VDE EN60335-2-38

Garland Commercial Ranges Ltd.
 1177 Kamato Road,
 Mississauga, Ontario
 L4W 1X4 CANADA

General Inquiries 1-905-624-0260
 USA Sales, Parts and Service 1-800-424-2411
 Canadian Sales 1-888-442-7526
 Canada or USA Parts/Service 1-800-427-6668

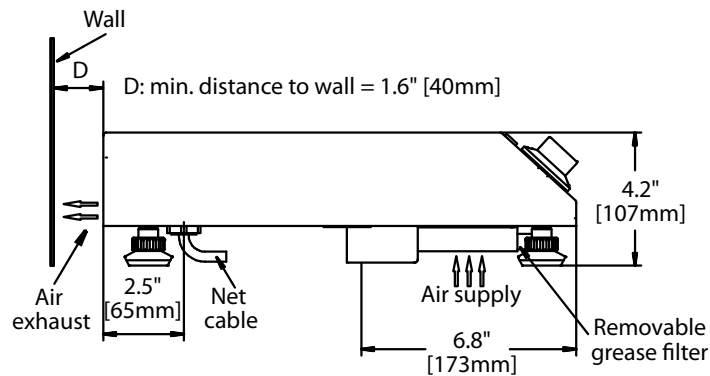
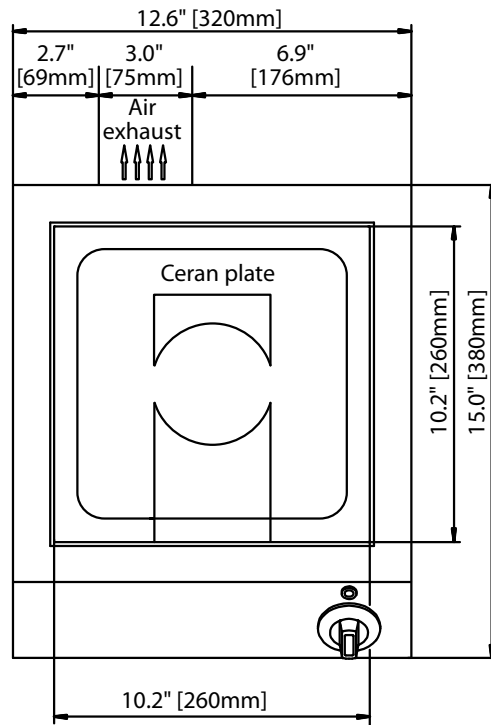



PLUG CONFIGURATIONS:		
Model	Electrical Characteristics	Plug
GI-BH/BA 3500	208V/60Hz/1Ø 240V/60Hz/1Ø	 NEMA 6-20P

Electrical Loading:			
Model	Watts	208/60/1	240/60/1
GI-BH/BA 3500	3500	17 amp	14 amp

Garland/U.S. Range products are not approved or authorized for home or residential use, but are intended for commercial applications only. Garland / U.S. Range will not provide service, warranty, maintenance or support of any kind other than in commercial applications.

Form# GI-BH/BA 3500 (12/06/11)