



# The Ultimate Outdoor Broiler

## OUTDOOR CHAR BROILERS

Job \_\_\_\_\_ Item # \_\_\_\_\_



Model CBBQ-60S-CP with optional 30" in-line griddle plate

### GAS CHAR BROILERS

BUILT-IN MODELS	BASE MODELS
CBBQ-30S-BI	CBBQ-30S
CBBQ-60S-BI	CBBQ-60S
PACKAGES	COMPLETE PACKAGES
CBBQ-30S-P	CBBQ-30S-CP
CBBQ-60S-P	CBBQ-60S-CP

### STANDARD FEATURES

- 20,000 BTUH steel burners every 7" (178mm) with independently controlled, adjustable valves for each burner
- Up to 160,000 BTUH per broiler in natural or LP gas
- Crossover pilot tube system
- Stainless steel radiant heat defectors
- Heavy-duty nickel-chrome plated top grates
- Stainless steel, front-mounted work deck 8" deep (203mm)
- Stainless steel valve panel
- Stainless steel outer construction
- Stainless steel water / grease pans
- Pressure regulator(s)
- Stainless steel stand
- Set of 4 heavy duty stainless steel legs with casters two with locks
- 3-channel stabilizer frame standard on 60" model; optional on 30" model
- Limited one year part & labor warranty

### SPECIFICATIONS

The Ultimate Outdoor Char Broilers are designed for broiling, grilling, steaming, roasting and holding all in a single piece of equipment.

CBBQ models feature 30" wide (762mm) or 60" wide (1524mm) by 24" deep (610mm) broiling areas. All models come standard with an all stainless steel exterior, an 8" deep (203mm) stainless steel work deck, stainless steel valve panel, stainless steel water/grease pans, heavy-duty nickel-chrome plated removable top grates.

**Built-in models** come with front removable water/grease pans and roll-top hood(s).

**Base models** come with stainless steel stand, legs, casters (two with locks) 3-channel stabilizer frame included on 60" mobile models.

**Packages** also include mobile tank caddy and 40 lb. L.P. tank(s).

**Complete Packages** also include the customer's choice of roll-top hood(s) or wind & splash guard(s).

20,000 BTUH steel burners are located every 7" (178mm) for maximum top heat intensity and greater production with independently controlled, adjustable burner valves for precision control and energy efficiency.

Standard crossover pilot tube system provides additional safety, energy savings and ease of operation.

Exteriors are fabricated of heavy gauge type 430 stainless steel with a #4 finish. Interiors are fabricated of 18-gauge high-heat resistant aluminized steel. Overall exterior dimensions are 33 1/2" deep (826mm) and either 32" (813mm) or 62 1/2" (1588mm) wide. Height is 36" (915mm) overall including stand, legs and casters.

One (1) year limited parts and labor warranty included.

### OPTIONS & ACCESSORIES

- Smoke & Roast roll-top hoods in 30" (762mm) or 60" (1524mm) sizes
- Wind & Splash guards in 30" (762mm)
- Steamer System 15" wide (381mm)
- Full size pan set with lid
- 1/2 Size pan set with lids
- Side mounted work deck / service shelf
- Rear mounted work deck / service shelf
- Stainless steel undershelves
- Ritclite cutting boards in 30" (762mm) or 60" (1524mm) sizes for front-mounted work decks
- 11" Wide (279mm) removable griddle plate
- 30" Wide (762mm) In-Line griddle plate
- All weather covers
- Propane tank caddies
- 3-channel stabilizer frame for 30" models
- 40 lb. LP tanks with hoses
- Built-in version

### CERTIFICATIONS



BAKERS PRIDE OVEN COMPANY, INC.  
30 Pine Street, New Rochelle, NY 10801  
914/576-0200 • 1-800-431-2745 • fax 914/576-0605  
www.bakerspride.com

*Continuous product improvement is a policy of Bakers Pride Oven Company. Therefore, specifications and design are subject to change without notification*

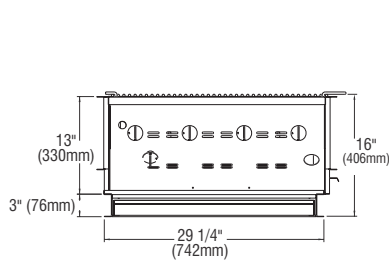

**BUILT-IN MODEL**

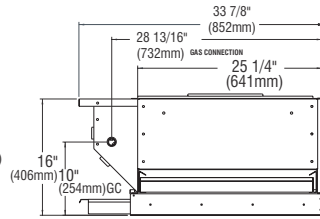

**BUILT-IN MODEL**

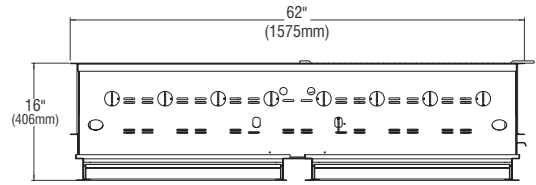

**BUILT-IN MODEL**

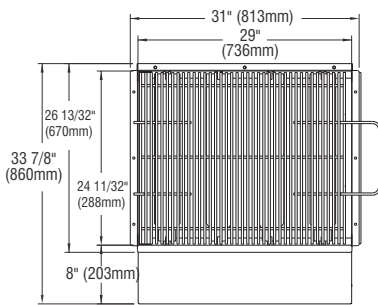
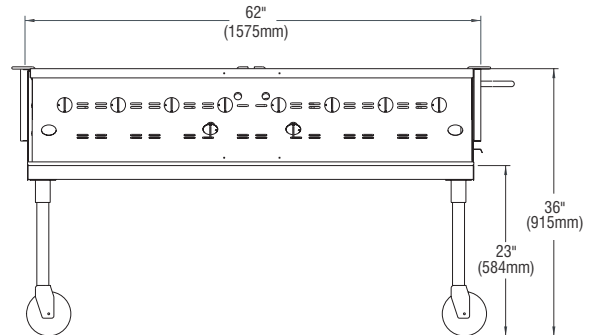
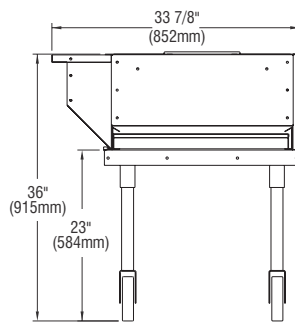
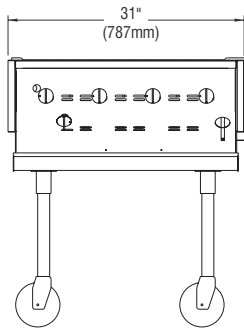

**TOP VIEW**

**SIDE VIEW**

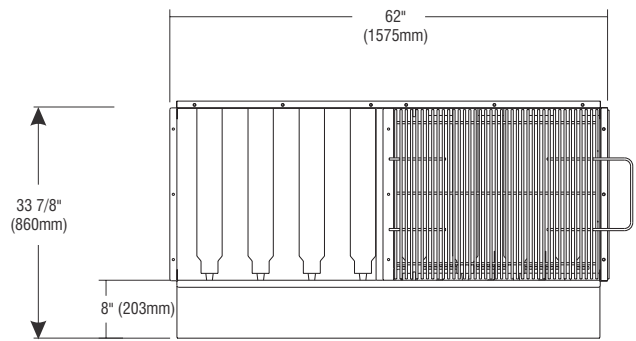

**TOP VIEW**

ALL DIMENSIONS NOMINAL

Model	Shipping Weight		Carton Dimensions				Crate Size			
	Lbs.	Kilos	Width Inches	mm	Depth Inches	mm	Height Inches	mm	Cubic Feet	Cubic Meter
CBBQ-30	300	136	33	838	30	762	19	483	10.8	.30
CBBQ-60	500	227	63	1600	30	762	19	483	20.8	.58

GAS SUPPLY						
Model	GAS TYPE	BTUH	KW	CONNECTION	# of CONNECTIONS	
CBBQ-30	LP	80,000	23.44	3/8"	1	
CBBQ-30	natural	80,000	23.44	3/4"	1	
CBBQ-60	LP	160,000	46.88	3/8"	2	
CBBQ-60	natural	160,000	46.88	3/4"	1	

CE certification not available in LP gas

SPECIFICATIONS										
Model	Broiling Area		# Top Grates	# of Burners	Overall Dimensions*					
	in.	mm			Width		Depth		Height	
	Inches	mm	Inches	mm	Inches	mm	Inches	mm	Inches	mm
CBBQ-30	29 x 24	736 x 610	1	4	31	813	33 7/8	860	36	915
CBBQ-60	58 x 24	1473 x 610	2	8	62	1575	33 7/8	860	36	915

\*Height includes stand & legs



BAKERS PRIDE OVEN COMPANY, INC.  
30 Pine Street, New Rochelle, NY 10801  
914/576-0200 • 1-800-431-2745 • fax 914/576-0605  
www.bakerspride.com

Continuous product improvement is a policy of Bakers Pride Oven Company. Therefore, specifications and design are subject to change without notification

TSW:03/06