

Project Name: _____ AIA#: _____

Model #: _____ Location: _____

SIS#: _____ Item #: _____ Quantity: _____



The Perfect Mix of Performance and Value

5 Quart Planetary Countertop Power Mixer

**Small Size,
Big Performance**

*10 speeds to power through any batch
of ingredients.*



Model

SP5

Standard Features

- 800 watt heavy-duty motor
- High-torque, geared transmission
- Ten speeds
- Electronic speed and load control
- Permanently lubricated transmission
- Thermal overload protection
- Easy action bowl lift
- Rigid cast aluminum body
- All stainless steel attachments
- Industry standard #10 attachment hub
- Dual bowl clamps to lock bowl in place
- NSF approved white powder coating
- 6-foot cord and ground plug

Standard Accessories/Attachments

- 5 qt stainless steel bowl (#304 series)
- Polycarbonate splash cover with ingredient chute
- Stainless steel flat beater
- Stainless steel wire whip
- Stainless steel spiral dough hook
- Spatula

Warranty

- *Two year parts and labor*

Optional Accessories/Attachments

- Mixer Cover
- Mixer table with under shelf
- Extended warranty

To select options, see complete list on back



AutoQuotes

Approved by: _____ Date: _____

2153 Dryden Rd., Dayton, OH 45439 | 937-299-5493 | 800-347-5423 | Fax: 937-299-4147 | www.globefoodequip.com

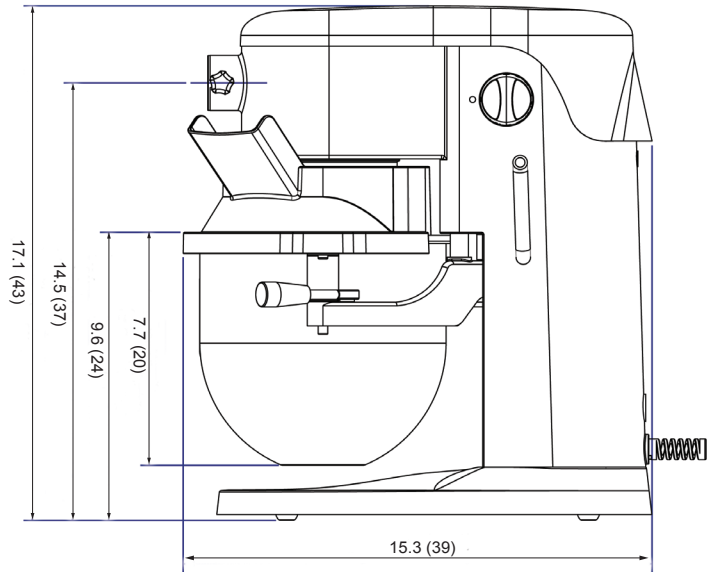
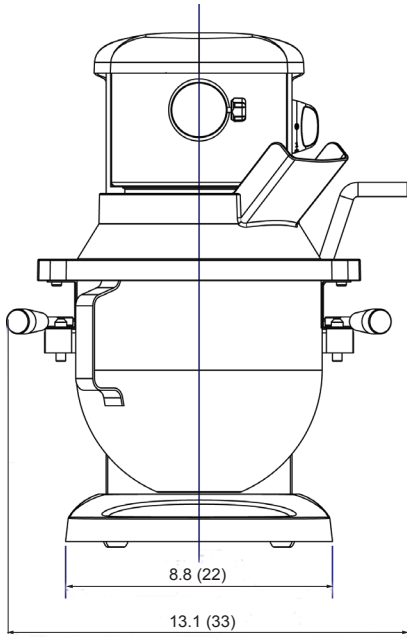

UNIT: INCHES (CM)

Drawings available through KCL at www.kclcad.com.

SPECIFICATIONS

Model	Motor	Volts	Amps	Transmission Type	Capacity	Agitator Speeds (RPMs)										Attachment Speeds	
						0	1	2	3	4	5	6	7	8	9	10	(RPMs)
SP5	800 w	115/60/1	4	Gear	5 qt 4.7 liter	OFF	30	50	70	90	105	120	145	165	180	200	50 to 450

Cord & Plug: Attached 6-foot flexible 3-wire cord with molded plug fits a grounded receptacle. NEMA 5-15P

DIMENSIONS | SHIPPING INFORMATION

Carton reinforced for shipping. The weight and dimensions of this reinforced carton are included below and may vary from shipment to shipment.

Model	Overall Dimensions	Net Wt	Shipping Dimensions	Shipping Wt
SP5	13" w x 15.3" d x 17" h (33 cm x 39 cm x 43 cm)	33 lbs (15 kg)	15" w x 18.5" d x 21.5" h (37 cm x 46 cm x 52 cm)	40 lbs (18 kg)

Mixer is constructed of a rigid cast aluminum body with 10 speeds. Unit has an 800 w motor with overload protection and a high torque, permanently lubricated, geared transmission. Mixer comes with 5 qt stainless steel bowl, flat beater, wire whip, and dough hook and splash cover with ingredient chute. Mixer has #10 attachment hub and bowl lift. Mixer is NSF and ETL listed. Two year parts and labor warranty.

OPTIONAL MIXER ACCESSORIES AND HUB ATTACHMENTS

- XXBOWL-5** 5 qt stainless steel bowl
- XXBEAT-5** Stainless steel flat beater
- XXHOOK-5** Stainless steel spiral dough hook

- XXWHIP-05** stainless steel wire whip
- XTable** stainless steel countertop mixer table with undershelf (30" W x 24" D x 24" H)

- EXTENDED WARRANTY SP-XD58** Extended warranty for SP5 mixer, extends factory warranty to 3 years. **Available only at time of purchase.**