

- KD-0350A
- KY-0350A
- KD-0350W
- KY-0350W

PRELIMINARY

K-0350 Ice Kube Machine



- Easy access to food zone with removal of two screws and lift-off door
- High-tech exterior with smudge and fingerprint resistant stainless-like finish
- White plastics in the food zone help identify areas needing cleaning
- Water shield, distribution tube, pump, floats, and trough removable by hand
- Available CleanAir™ pack controls the growth of bacteria and fungi that form slime and cause odors in the food zone

WARRANTY:

Ice Maker: 1 year Parts & Labor
 Evaporator: 5 year Parts
 Compressor: 5 year Parts



HALF KUBE

$\frac{3}{8}'' \times 1\frac{1}{8}'' \times \frac{7}{8}''$
 (.95 x 2.86 x 2.22 cm)

= 100%



KUBE

$\frac{7}{8}'' \times \frac{7}{8}'' \times \frac{7}{8}''$
 (2.22 x 2.22 x 2.22 cm)

= 100%



K-0350
ICE KUBE MACHINE















KOOLAIRE®

by **Manitowoc**









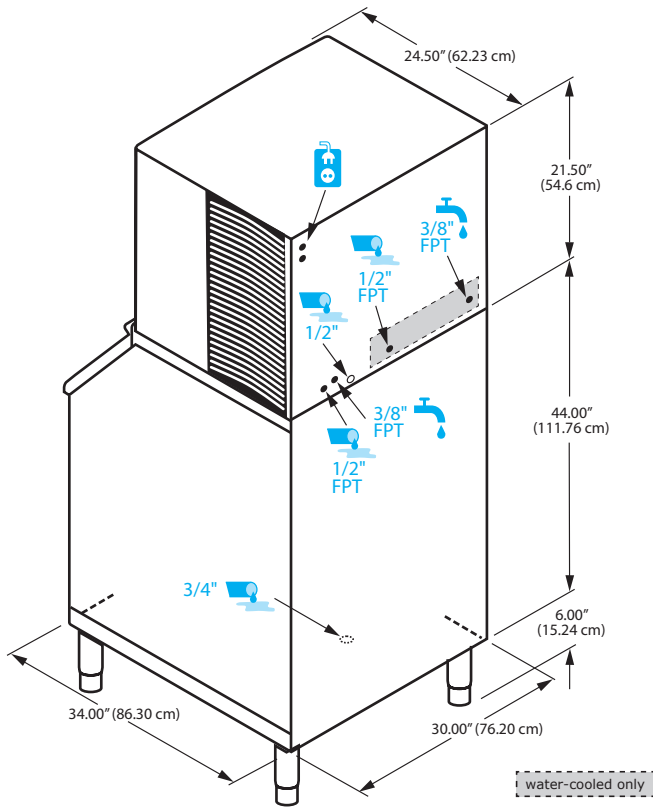



2110 SOUTH 26TH ST | MANITOWOC, WI 54220 USA | 1-920-682-0161 [www.kool-aire.com]



K-0350 ICE KUBE MACHINE

Icon: Ice Cube	Icon: Compressor	Icon: Ice Cubes	24h    			
			70°/50°F 21°/10°C	90°/70°F 32°/21°C		
KD-0350A			375 lbs	300 lbs	6.2	22.0
			170 kg	136 kg		
KY-0350A			400 lbs	320 lbs	6.2	22.0
			181 kg	145 kg		
KD-0350W			381 lbs	305 lbs	5.2	22.0
			173 kg	138 kg		
KY-0350W			388 lbs	310 lbs	5.2	22.0
			176 kg	141 kg		



 Minimum		 Maximum
35°F 1.7°C		110°F 43.3°C
35°F 1.7°C		90°F 32.2°C
20psi 138 kPA		80psi 551 kPA
 12.1		
 11.4		
		20 Amps
 160 lbs 73 kg		
 140 lbs 64 kg		

KOOLAIRE®

by **Manitowoc**

2110 SOUTH 26TH ST | MANITOWOC, WI 54220 USA | 1-920-682-0161 [www.kool-aire.com]

5107 ©2013 Koolaire 5/13 Specifications subject to change.

