

- KD-0600A
- KY-0600A
- KD-0600W
- KY-0600W

PRELIMINARY

K-0600 Ice Kube Machine



- Easy access to food zone with removal of two screws and lift-off door
- High-tech exterior with smudge and fingerprint resistant stainless-like finish
- White plastics in the food zone help identify areas needing cleaning
- Water shield, distribution tube, pump, floats, and trough removable by hand
- Available CleanAir™ pack controls the growth of bacteria and fungi that form slime and cause odors in the food zone

WARRANTY:

Ice Maker: 1 year Parts & Labor
 Evaporator: 5 year Parts
 Compressor: 5 year Parts



HALF KUBE

$\frac{3}{8}'' \times 1\frac{1}{8}'' \times \frac{7}{8}''$
 (.95 x 2.86 x 2.22 cm)

= 100%



KUBE

$\frac{7}{8}'' \times \frac{7}{8}'' \times \frac{7}{8}''$
 (2.22 x 2.22 x 2.22 cm)

= 100%



K-0600
ICE KUBE MACHINE

KOOLAIRE®

by **Manitowoc**

















US LISTED











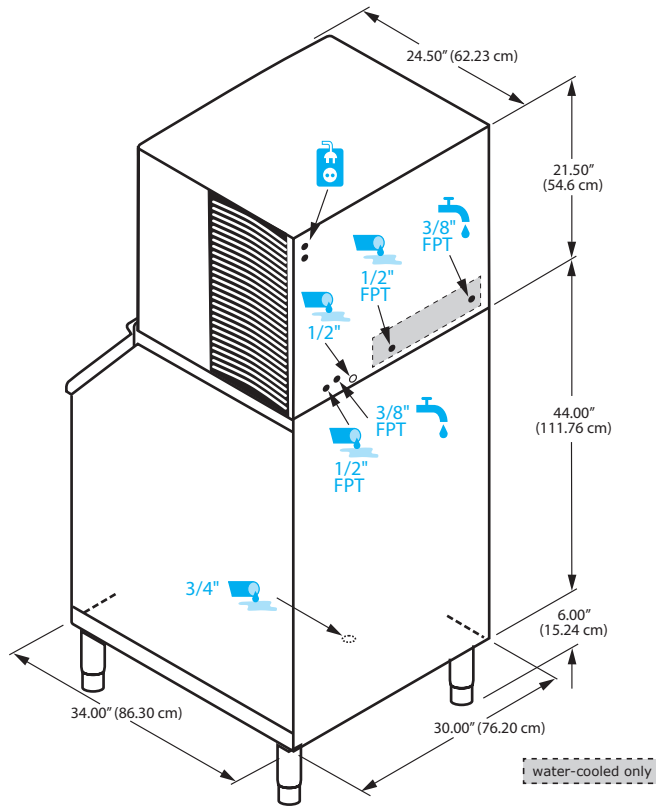



2110 SOUTH 26TH ST | MANITOWOC, WI 54220 USA | 1-920-682-0161 [www.kool-aire.com]



K-0600 ICE KUBE MACHINE

				 			
				70°/50°F 21°/10°C	90°/70°F 32°/21°C	[kWh/ 100 lbs ice]	[gal/100 lbs ice]
KD-0600A			599 lbs	485 lbs	5.9	21.0	
			272 kg	225 kg			
KY-0600A			609 lbs	538 lbs	5.9	21.0	
			276 kg	244 kg			
KD-0600W			564 lbs	494 lbs	5.6	21.0	
			256 kg	224 kg			
KY-0600W			583 lbs	510 lbs	5.6	21.0	
			264 kg	231 kg			



 Minimum		 Maximum
35°F 1.7°C		110°F 43.3°C
35°F 1.7°C		90°F 32.2°C
20psi 138 kPA		80psi 551 kPA
 9.2	A	
 8.8		
		15 Amps
 194 lbs 88 kg		
 194 lbs 88 kg		

KOOLAIRE®

by **Manitowoc**

2110 SOUTH 26TH ST | MANITOWOC, WI 54220 USA | 1-920-682-0161 | www.kool-aire.com