

- KD-0600A
- KY-0600A
- KD-0600W
- KY-0600W

# K-0600 Ice Kube Machine



- Easy access to food zone with removal of two screws and lift-off door
- High-tech exterior with smudge and fingerprint resistant stainless-like finish
- White plastics in the food zone help identify areas needing cleaning
- Water shield, distribution tube, pump, floats, and trough removable by hand
- Available CleanAir™ pack controls the growth of bacteria and fungi that form slime and cause odors in the food zone

### WARRANTY:

Ice Maker: 3 year Parts & Labor  
 Evaporator: 5 year Parts & Labor  
 Compressor: 5 year Parts & 3 year Labor



### HALF KUBE

$\frac{3}{8}'' \times 1\frac{1}{8}'' \times \frac{7}{8}''$   
 (.95 x 2.86 x 2.22 cm)

= 100%



### KUBE

$\frac{7}{8}'' \times \frac{7}{8}'' \times \frac{7}{8}''$   
 (2.22 x 2.22 x 2.22 cm)

= 100%

Refrigerant R410A



K-0600  
ICE KUBE MACHINE

*Koolaire K-0600 Ice Kube Machine on a K570 bin.*

**KOOLAIRE**®

by **Manitowoc**















2110 SOUTH 26TH ST | MANITOWOC, WI 54220 USA | 1-920-682-0161 [ [www.kool-aire.com](http://www.kool-aire.com) ]



US LISTED



# K-0600 ICE KUBE MACHINE

|          |  |  |  |  24h |  |  |  |
|----------|---|---|---|--|---|---|---|
|          |   |   |   | 70°/50°F<br>21°/10°C   | 90°/70°F<br>32°/21°C  | [kWh/<br>100 lbs ice]   | [gal/100<br>lbs ice]  |
| KD-0600A |  |  | 599 lbs   | 485 lbs  | 6.0   | 21.0  |   |
|          |   |   | 272 kg  | 225 kg   |   |   |   |
| KY-0600A |  |  | 609 lbs   | 538 lbs  | 6.0   | 21.0  |   |
|          |   |   | 276 kg  | 244 kg   |   |   |   |
| KD-0600W |  |  | 564 lbs   | 494 lbs  | 5.0   | 21.0  |   |
|          |   |   | 256 kg  | 224 kg   |   |   |   |
| KY-0600W |  |  | 583 lbs   | 510 lbs  | 5.0   | 21.0  |   |
|          |   |   | 264 kg  | 231 kg   |   |   |   |

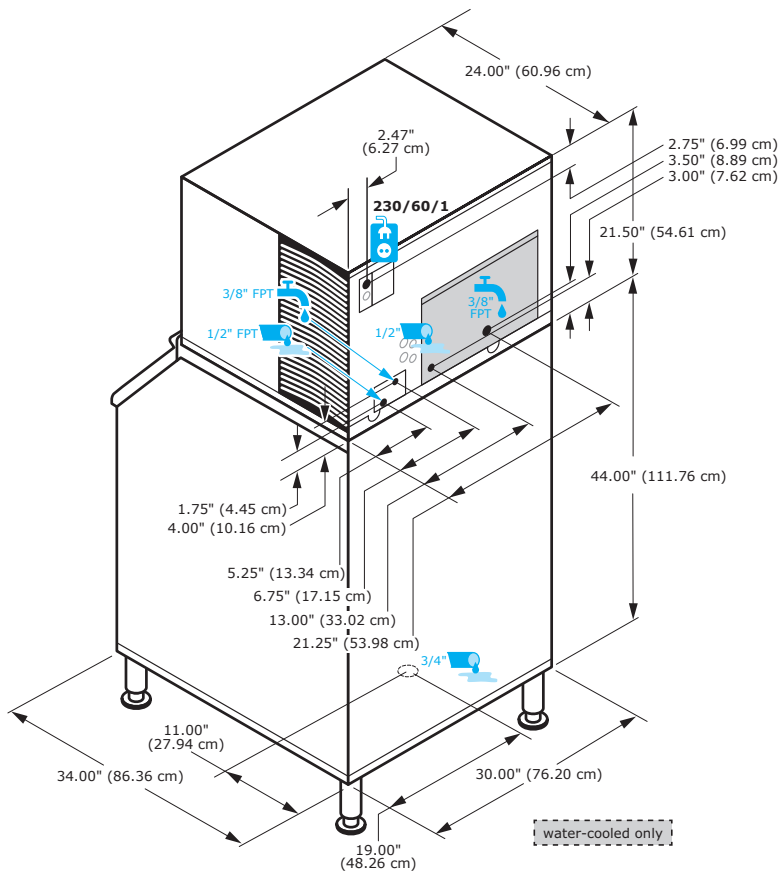

| Minimum          | Maximum          |
|------------------|------------------|
| 35°F<br>1.7°C    | 110°F<br>43.3°C  |
| 35°F<br>1.7°C    | 90°F<br>32.2°C   |
| 20psi<br>138 kPa | 80psi<br>551 kPa |
| 9.2<br>8.8       | A                |
|                  | 15 Amps          |
| 167 lbs<br>78 kg |                  |
| 176 lbs<br>80 kg |                  |

Water cooled condenser water usage/100 lbs. or 45.4 kg. of ice: 170 gals. / 644 L.

| Popular Accessories      |                              |                       |                |
|--------------------------|------------------------------|-----------------------|----------------|
| Artic Pure Water Filters | Dispenser Bin Thermostat Kit | Top Air Discharge Kit | Clean Air Pack |
| AR-Pre & AR 10000        | K-00457                      | K-00379               | K-00206        |

**KOOLAIRE®**  
by **Manitowoc**

2110 SOUTH 26TH ST | MANITOWOC, WI 54220 USA | 1-920-682-0161 [ [www.kool-aire.com](http://www.kool-aire.com) ]